

COBALT®

9978-ANC-MON

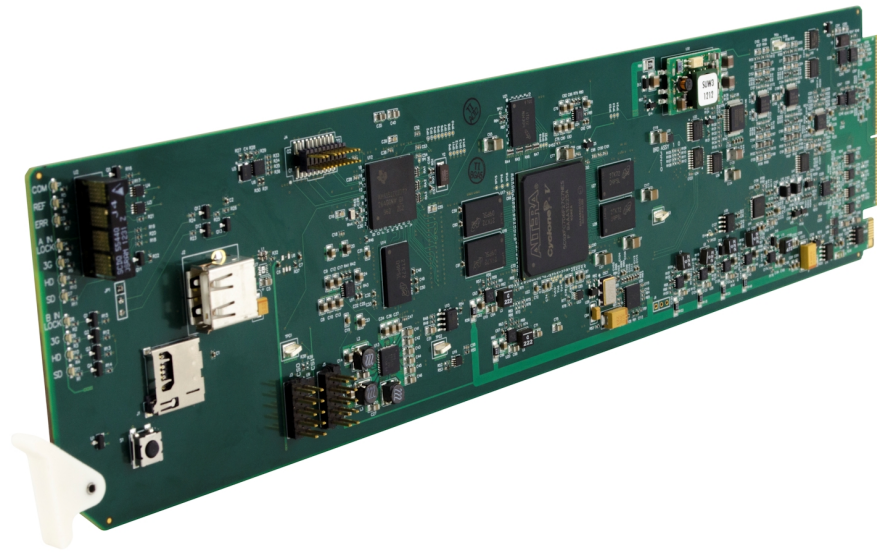

**3G/HD/SD-SDI Ancillary Data Monitoring Probe
with Multiple-Protocol Data Payload SDI/HDMI Display
and Fault Detection/Forwarding**

Product Manual

COBALT®

Cobalt Digital Inc.

2506 Galen Drive
Champaign, IL 61821
Voice 217.344.1243 • Fax 217.344.1245
www.cobaltdigital.com

Copyright

©Copyright 2018, Cobalt Digital Inc. All Rights Reserved.

Duplication or distribution of this manual and any information contained within is strictly prohibited without the express written permission of Cobalt Digital Inc. This manual and any information contained within, may not be reproduced, distributed, or transmitted in any form, or by any means, for any purpose, without the express written permission of Cobalt Digital Inc. Reproduction or reverse engineering of software used in this device is prohibited.

Disclaimer

The information in this document has been carefully examined and is believed to be entirely reliable. However, no responsibility is assumed for inaccuracies. Furthermore, Cobalt Digital Inc. reserves the right to make changes to any products herein to improve readability, function, or design. Cobalt Digital Inc. does not assume any liability arising out of the application or use of any product or circuit described herein.

Trademark Information

Cobalt[®] is a registered trademark of Cobalt Digital Inc.

openGear[®] is a registered trademark of Ross Video Limited. **DashBoard**[™] is a trademark of Ross Video Limited.

Dolby[®] is a registered trademark of Dolby Laboratories, Inc. Other product names or trademarks appearing in this manual are the property of their respective owners.

Congratulations on choosing the Cobalt[®] 9978-ANC-MON 3G/HD/SD-SDI Ancillary Data Monitoring Probe with Multiple-Protocol Data Payload SDI/HDMI Display and Fault Detection/Forwarding. The 9978-ANC-MON is part of a full line of modular processing and conversion gear for broadcast TV environments. The Cobalt Digital Inc. line includes video decoders and encoders, audio embedders and de-embedders, distribution amplifiers, format converters, remote control systems and much more. Should you have questions pertaining to the installation or operation of your 9978-ANC-MON, please contact us at the contact information on the front cover.

Manual No.:	9978-ANC-MON-OM
Document Version:	V1.1
Release Date:	October 25, 2018
Applicable for Firmware Version (or greater):	2.067 or greater
Description of product/manual changes:	- Initial non-preliminary release. This firmware version has significant user interface changes versus prior firmware versions and the use of this new Product Manual is strongly recommended.

Table of Contents

Chapter 1	Introduction	1-1
	Overview	1-1
	9978-ANC-MON Card Software Versions and this Manual.....	1-1
	Cobalt Reference Guides	1-2
	Manual Conventions.....	1-2
	Warnings, Cautions, and Notes	1-3
	Labeling Symbol Definitions.....	1-3
	Safety and Regulatory Summary	1-4
	Warnings.....	1-4
	Cautions	1-4
	EMC Compliance Per Market	1-4
	9978-ANC-MON Functional Description	1-5
	Status Field Displays	1-6
	9978-ANC-MON Program Video Input/Output Formats	1-8
	Video Processing Description	1-8
	Audio Processor Description	1-9
	User Presets	1-9
	User Control Interface	1-10
	9978-ANC-MON Rear I/O Modules.....	1-12
	Technical Specifications.....	1-12
	Contact Cobalt Digital Inc.....	1-13
	Warranty and Service Information	1-14
	Cobalt Digital Inc. Limited Warranty.....	1-14
Chapter 2	Installation	2-1
	Overview	2-1
	Installing the 9978-ANC-MON Into a Frame Slot.....	2-1
	Installing a Rear I/O Module	2-3
	9978-ANC-MON Rear I/O Modules.....	2-4
	Setting Up 9978-ANC-MON Network Remote Control	2-8
Chapter 3	Operating Instructions	3-1
	Overview	3-1
	Control and Display Descriptions.....	3-1
	Function Menu/Parameter Menu Overview	3-2
	DashBoard™ User Interface.....	3-3

Accessing the 9978-ANC-MON Card via Remote Control.....	3-4
Accessing the 9978-ANC-MON Card Using DashBoard™.....	3-4
Checking 9978-ANC-MON Card Information	3-6
Overview of Status Displays on Output Video	3-7
Overview of Setting Up Images and Status Fields on Output Raster	3-7
9978-ANC-MON Function Menu List and Descriptions.....	3-9
Layout Quicksets	3-10
Status Field Layout Controls	3-10
Input Selection	3-13
Input Video Layout Controls	3-14
Audio Meter Overlay Controls	3-15
Output Audio Routing/Controls	3-19
Audio Monitoring Setup Controls	3-20
SCTE 104 Status Setup Controls	3-21
User DID/SDID Monitoring Setup Controls	3-22
Output Format Controls	3-23
Clock (Wall-Clock Time/LTC) Controls	3-25
Presets	3-27
Admin	3-29
User Log	3-32
Troubleshooting	3-32
Error and Failure Indicator Overview	3-32
Basic Troubleshooting Checks.....	3-36
9978-ANC-MON Processing Error Troubleshooting	3-37
Troubleshooting Network/Remote Control Errors.....	3-38
In Case of Problems	3-38

Introduction

Overview

This manual provides installation and operating instructions for the 9978-ANC-MON 3G/HD/SD-SDI Ancillary Data Monitoring Probe with Multiple-Protocol Data Payload SDI/HDMI Display and Fault Detection/Forwarding card (also referred to herein as the 9978-ANC-MON).

This manual consists of the following chapters:

- **Chapter 1, “Introduction”** – Provides information about this manual and what is covered. Also provides general information regarding the 9978-ANC-MON.
- **Chapter 2, “Installation”** – Provides instructions for installing the 9978-ANC-MON in a frame, and connecting signal and control cabling to the 9978-ANC-MON.
- **Chapter 3, “Operating Instructions”** – Provides overviews of setup/operating controls and instructions for using the 9978-ANC-MON.

This chapter contains the following information:

- **9978-ANC-MON Card Software Versions and this Manual (p. 1-1)**
- **Manual Conventions (p. 1-2)**
- **Safety and Regulatory Summary (p. 1-4)**
- **9978-ANC-MON Functional Description (p. 1-5)**
- **Technical Specifications (p. 1-12)**
- **Contact Cobalt Digital Inc. (p. 1-13)**
- **Warranty and Service Information (p. 1-14)**

9978-ANC-MON Card Software Versions and this Manual

When applicable, Cobalt Digital Inc. provides for continual product enhancements through software updates. As such, functions described in this manual may pertain specifically to cards loaded with a particular software build.

The Software Version of your card can be checked by viewing the **Card Info** menu in DashBoard™. See Checking 9978-ANC-MON Card Information (p. 3-6) in Chapter 3, “Operating Instructions” for more information. You can then check our website for the latest software version currently released for the card as described below.

Note: Not all functionality described in this manual may appear on cards with initial software versions.

Check our website and proceed as follows if your card’s software does not match the latest version:

Card Software earlier than latest version	<p>Card is not loaded with the latest software. Not all functions and/or specified performance described in this manual may be available.</p> <p>You can update your card with new Update software by going to the Support>Firmware Downloads link at www.cobaltdigital.com. Download “Firmware Update Guide”, which provides simple instructions for downloading the latest firmware for your card onto your computer, and then uploading it to your card through DashBoard™.</p> <p>Software updates are field-installed without any need to remove the card from its frame.</p>
Card Software newer than version in manual	<p>A new manual is expediently released whenever a card’s software is updated and specifications and/or functionality have changed as compared to an earlier version (a new manual is not necessarily released if specifications and/or functionality have not changed). A manual earlier than a card’s software version may not completely or accurately describe all functions available for your card.</p> <p>If your card shows features not described in this manual, you can check for the latest manual (if applicable) and download it by going to the card’s web page on www.cobaltdigital.com.</p>

Cobalt Reference Guides

From the Cobalt® web home page, go to **Support>Reference Documents** for easy to use guides covering network remote control, card firmware updates, example card processing UI setups and other topics.

Manual Conventions

In this manual, display messages and connectors are shown using the exact name shown on the 9978-ANC-MON itself. Examples are provided below.

- Card-edge display messages are shown like this:

Boot

- Connector names are shown like this: **SDI IN A**

In this manual, the terms below are applicable as follows:

- **9978-ANC-MON** refers to the 9978-ANC-MON 3G/HD/SD-SDI Ancillary Data Monitoring Probe with Multiple-Protocol Data Payload SDI/HDMI Display and Fault Detection/Forwarding card.
- **Frame** refers to the HPF-9000, OG3-FR, 8321, or similar 20-slot frame that houses Cobalt® or other cards.
- **Device** and/or **Card** refers to a Cobalt® or other card.
- **System** and/or **Video System** refers to the mix of interconnected production and terminal equipment in which the 9978-ANC-MON and other cards operate.
- Functions and/or features that are available only as an option are denoted in this manual like this:



Warnings, Cautions, and Notes

Certain items in this manual are highlighted by special messages. The definitions are provided below.

Warnings

Warning messages indicate a possible hazard which, if not avoided, could result in personal injury or death.

Cautions

Caution messages indicate a problem or incorrect practice which, if not avoided, could result in improper operation or damage to the product.

Notes

Notes provide supplemental information to the accompanying text. Notes typically precede the text to which they apply.

Labeling Symbol Definitions

	<p>Important note regarding product usage. Failure to observe may result in unexpected or incorrect operation.</p>
	<p>Electronic device or assembly is susceptible to damage from an ESD event. Handle only using appropriate ESD prevention practices.</p> <p>If ESD wrist strap is not available, handle card only by edges and avoid contact with any connectors or components.</p>
	<p>Symbol (WEEE 2002/96/EC)</p> <p>For product disposal, ensure the following:</p> <ul style="list-style-type: none"> • Do not dispose of this product as unsorted municipal waste. • Collect this product separately. • Use collection and return systems available to you.

Safety and Regulatory Summary

Warnings

! WARNING !

To reduce risk of electric shock do not remove line voltage service barrier cover on frame equipment containing an AC power supply. NO USER SERVICEABLE PARTS INSIDE. REFER SERVICING TO QUALIFIED SERVICE PERSONNEL.

Cautions

CAUTION

This device is intended for environmentally controlled use only in appropriate video terminal equipment operating environments.

CAUTION

This product is intended to be a component product of an openGear® frame. Refer to the openGear® frame Owner's Manual for important safety instructions regarding the proper installation and safe operation of the frame as well as its component products.

CAUTION

Heat and power distribution requirements within a frame may dictate specific slot placement of cards. Cards with many heat-producing components should be arranged to avoid areas of excess heat build-up, particularly in frames using only convection cooling. The 9978-ANC-MON has a moderate power dissipation (<18 W). As such, avoiding placing the card adjacent to other cards with similar dissipation values if possible.

CAUTION

If required, make certain Rear I/O Module(s) is installed before installing the 9978-ANC-MON into the frame slot. Damage to card and/or Rear I/O Module can occur if module installation is attempted with card already installed in slot.

CAUTION

If card resists fully engaging in rear I/O module mating connector, check for alignment and proper insertion in slot tracks. Damage to card and/or rear I/O module may occur if improper card insertion is attempted.

CAUTION

The 9978-ANC-MON FPGA is designed for a normal-range operating temperature around 85° C core temperature. Operation in severe conditions exceeding this limit for non-sustained usage are within device operating safe parameters, and can be allowed by setting this control to Disable. However, the disable (override) setting should be avoided under normal conditions to ensure maximum card protection.

EMC Compliance Per Market

Market	Regulatory Standard or Code
United States of America	FCC "Code of Federal Regulations" Title 47 Part15, Subpart B, Class A
Canada	ICES-003
International	CISPR 24:2010 IEC 61000-4-2:2008 IEC 61000-4-3:2006 with A1:2007 and A2:2010 IEC 61000-4-4:2004 IEC 61000-4-6:2008 IEC 61000-6-3:2006 with A1:2010 CISPR 22:2008

9978-ANC-MON Functional Description

Figure 1-1 shows a typical layout using the card to show one of the SDI inputs, and numerous status fields related to the input.

Figure 1-2 shows a functional block diagram of the 9978-ANC-MON. The 9978-ANC-MON includes input processing functions to accommodate up to five SDI inputs. User-selectable status fields allow the checking for various ancillary data types (and displaying parametric values or other information as applicable). The 9978-ANC-MON also allows up to any five of the program video input rasters to be displayed in a multiviewer format on the combined video output of the card. The card combined output is available as a 2x DA 3G/HD/SD-SDI output or HDMI/DVI. The output raster format is user-configurable via an output video scaler.

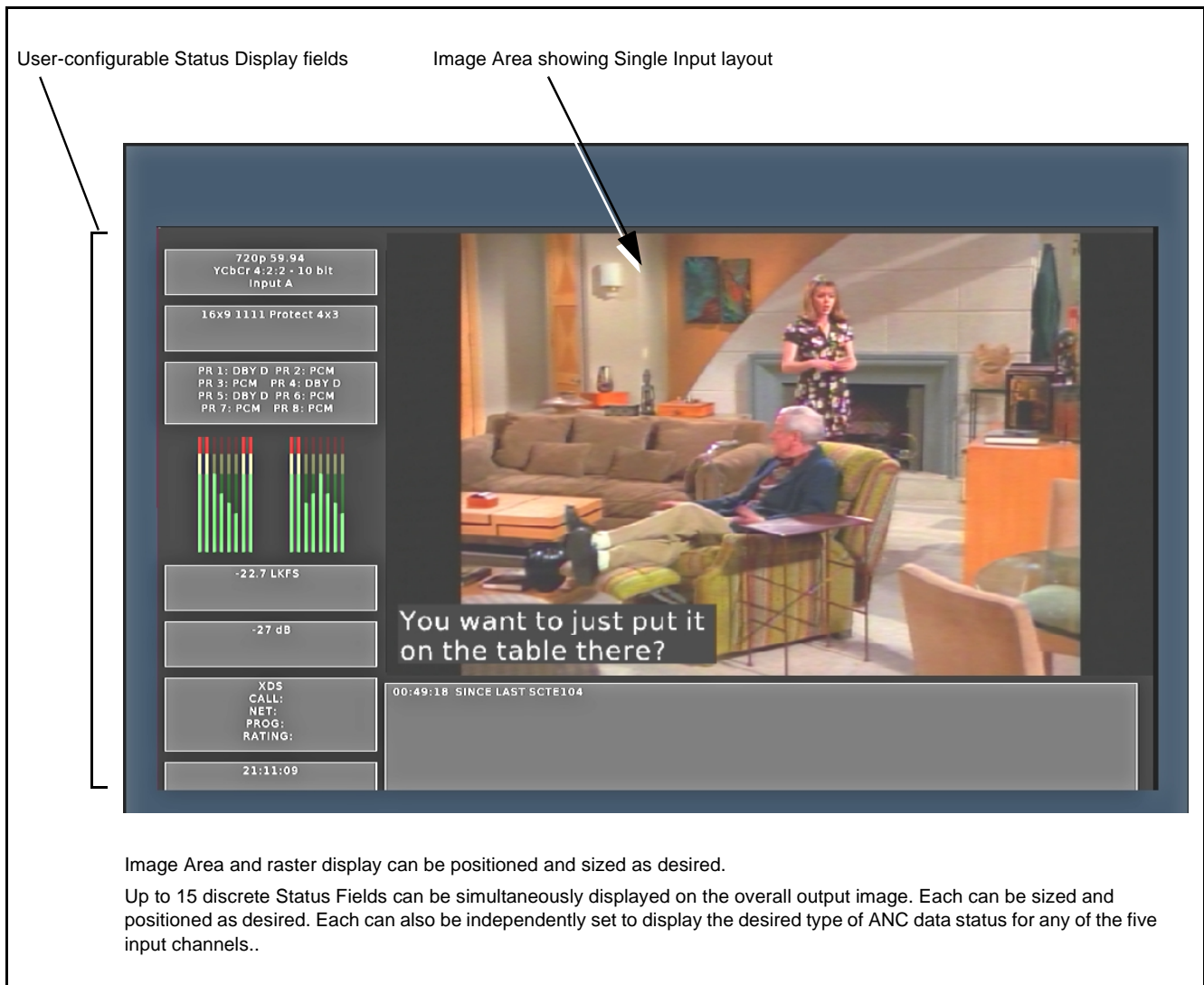

Image Area and raster display can be positioned and sized as desired.

Up to 15 discrete Status Fields can be simultaneously displayed on the overall output image. Each can be sized and positioned as desired. Each can also be independently set to display the desired type of ANC data status for any of the five input channels..

Figure 1-1 Typical 9978-ANC-MON Display Layout and Status Fields

Status Field Displays

Each Status Field can be set to display any of the data types/status as listed below. Associated with each Status Field setup UI is a drop-down to correlate the Status Field with the desired card SDI input (**Input A** thru **Input E**).

- **Input Format** – Shows input raster/rate, as well as colorspace type and encoding of selected input (for example, “720p 59.94 YCbCr 10 bit”). If no input is present, “No Input” is displayed.
- **AFD Coding/Presence** – Shows AFD description/code (for example, “16x9 1111 Protect 4x3”). If AFD coding is not present, “No AFD” is displayed.
- **SCTE104 Log** – Shows elapsed time since last SCTE104 message was present on the selected input.
- **Audio Presence** – Shows breakdown on each embedded pair 1 thru 8 for the selected input (for example, shows “PCM” for pairs containing PCM and shows “DBY D” for pairs consisting of a Dolby D pair).
- **LKFS** – Shows LKFS of up to 5 audio channels for the selected input.
- **Dolby Pair n** – For selected channel pair for selected input, shows dialnorm metadata for Dolby pair (if Dolby is not present on pair, “PCM” is displayed). Drop-down selector allows pair 1 thru pair 8 to be monitored.
- **CC Presence** – Shows presence and type/channel of CEA closed captioning for the selected input (for example, ‘CEA 608 1 CEA 708----’ indicating CEA 608 Ch1 detected; no CEA 708). If no CC is detected, dashes are shown for both CEA 608 and 708.
- **CC Overlay** – Provides a burn-in of closed captioning text.
- **XDS** – Shows XDS Call, Net, Prog, and Rating parameters where present for the selected input. If no XDS is present, the fields to the right of each parameter type show blank.
- **User DID/SDID Presence** – Shows presence of user-configurable DID/SDID locations for the selected input.
- **Clock** – Shows “wall clock” time as set using card Clock setup controls.
- **SCTE104 Latest** – Shows latest SCTE104 message. If no message has been received since card alive-time, field is displayed blank.
- **Disabled** – Removes the Status Field and its background from the output raster.

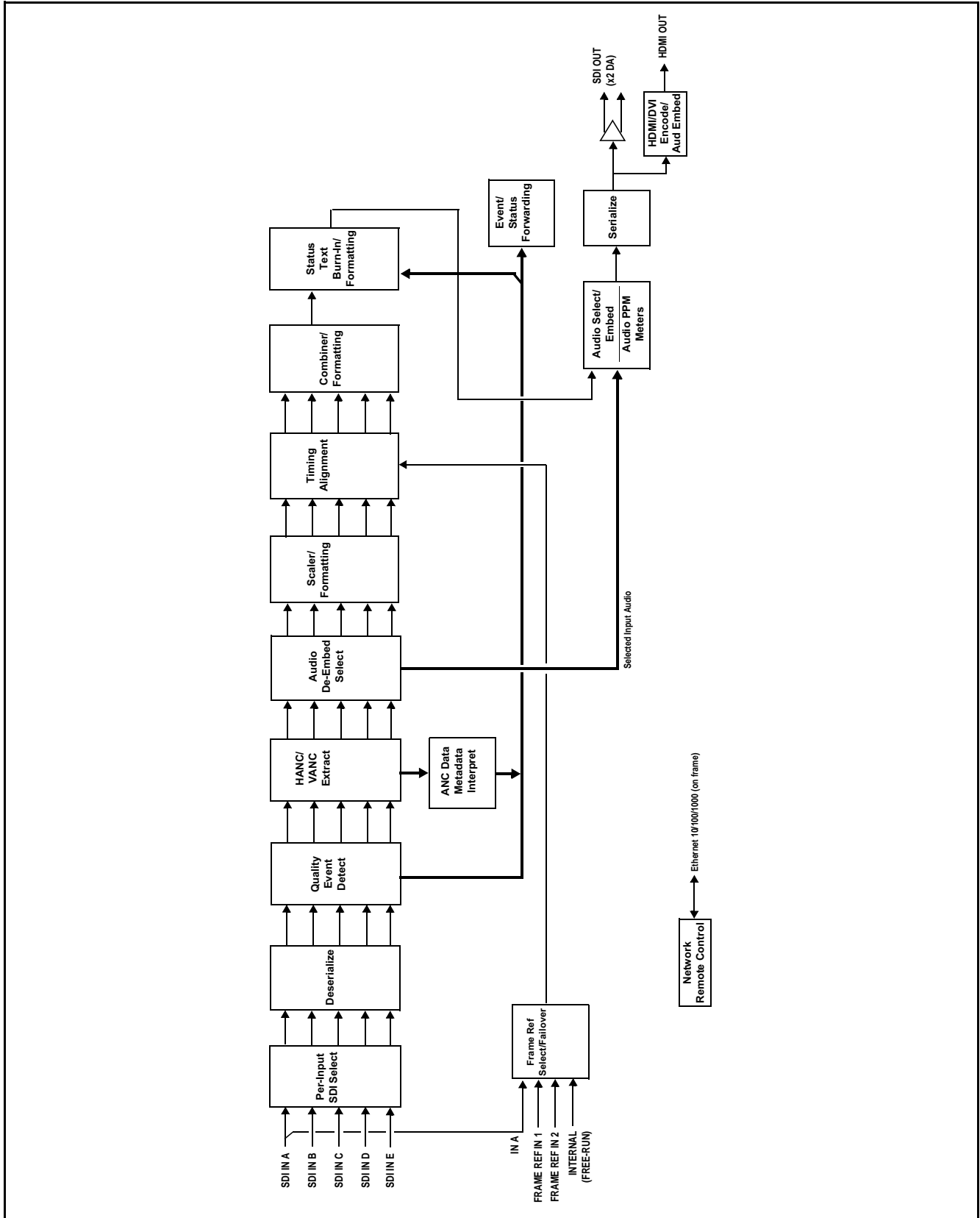

Figure 1-2 9978-ANC-MON Functional Block Diagram

9978-ANC-MON Program Video Input/Output Formats

The 9978-ANC-MON provides the following inputs and outputs:

- **Inputs:**
 - **SDI IN A** thru **SDI IN E** – five 3G/HD/SD-SDI coaxial video inputs
- **Outputs:**
 - **3G/HD/SD-SDI OUT** – 2x DA 3G/HD/SD-SDI multi-image video outputs
 - **HDMI/DVI OUT** – Multi-image HDMI/DVI out with selectable audio embedding (suitable for direct connection to monitor panels)

Video Processing Description

The 9978-ANC-MON features input select and validity check functions, timing alignment, and scaling functions as described below.

Input Video Select Function

Up to five individual SDI inputs can be received by the card. Any of the inputs can be queried by various data monitors for selected data and conditions.

Input Video Layout

The active video raster of up to five of the any five SDI inputs can be fed to the card output as a multiviewer Picture-In-Picture (PiP) display, along with a band of user-configurable status displays surrounding the image area. User controls allow the sizing and positioning of each PiP image.

Quint Timing Alignment Function

This function provides for frame alignment control of the five SDI inputs using either one of two external **FRAME REF IN (1,2)** reference signals distributed with the card frame, **SDI Input A**, or card internal clock reference as a frame reference. As such, the card can accommodate asynchronous program video inputs. Selectable failover allows alternate reference selection should the initial reference source become unavailable or invalid.

This function also allows frame offset delay to be added between the output video and the frame sync reference. Frame sync can select from either of two card frame reference sources, input video, or free-run (internal) timing.

SCTE 104 Log Setup

This tool provides setup of SCTE 104 log queries where various message types can be propagated or ignored. Propagated messages are deposited into a log (which can be downloaded through DashBoard if desired). A message history is also displayed.

Output Format (Scaler) Function

The scaler function provides output conversion to 3G/HD 1080 interlaced or progressive outputs. (Background fill of this device is optimized for 1080 formats, therefore all output format choices are limited to 1080 choices.)

The card allows output video raster/rate choices unrelated to the input rates (for example, PAL 50Hz rate for NTSC 59.94Hz input rates). However, frames will be dropped/duped when performing such conversions.

Audio Processor Description

Audio Select/Embed

The audio processor operates as an internal audio router for selecting card video input embedded channels 1-16 as channels (as a four-group package) to be embedded into the combined PiP SDI and HDMI video outputs. The audio processor function operates with the timing alignment function to align audio with the selected reference.

- Note:**
- Output audio always corresponds to a single selected video input. Output embedded channels cannot be sourced from a mix of various input embedded channels.
 - To maintain conformance with CEA-861D HDMI audio channel line-up specifications and industry standard SDI convention, the HDMI output swaps between the C and LFE channels for the HDMI output.

Audio PPM Meters

The audio of any video input can be displayed as audio PPM meters. The setup controls provide audio meters in several formats (channel count) as desired (from 2-bar stereo up to all four embedded audio groups for the audio associated with the selected input). User controls allow setting meter complement, position, size, and other graphic attributes.

User Presets

Most layout and functional query setup on the card is largely user configurable. As such, there are no “out of the box” templates (since the layout and functional aspects are highly flexible). However, when a setup is completed, all aspects (or only desired aspects) can be saved to a preset, which allows permanent saving of the setup as well as instant recall of the setup. In this manner, numerous custom setups can be saved and recalled as desired.

User Control Interface

Figure 1-3 shows the user control interface options for the 9978-ANC-MON. These options are individually described below.

Note: All user control interfaces described here are cross-compatible and can operate together as desired. Where applicable, any control setting change made using a particular user interface is reflected on any other connected interface.

- **DashBoard™ User Interface** – Using DashBoard™, the 9978-ANC-MON and other cards installed in openGear®¹ frames can be controlled from a computer and monitor.

DashBoard™ allows users to view all frames on a network with control and monitoring for all populated slots inside a frame. This simplifies the setup and use of numerous modules in a large installation and offers the ability to centralize monitoring. Cards define their controllable parameters to DashBoard™, so the control interface is always up to date.

The DashBoard™ software can be downloaded from the Cobalt Digital Inc. website: www.cobaltdigital.com (enter “DashBoard” in the search window). The DashBoard™ user interface is described in Chapter 3, “Operating Instructions”.

- **Cobalt® OGCP-9000 and OGCP-9000/CC Remote Control Panels** – The OGCP-9000 and OGCP-9000/CC Remote Control Panels are not intended to be used for PiP sizing and other visual abstract configuration aspects. However, the control panel can be used as a convenient “one-button” control surface for launching non-abstract functions such as a user preset that invokes a custom setup.

1. openGear® is a registered trademark of Ross Video Limited. DashBoard™ is a trademark of Ross Video Limited.

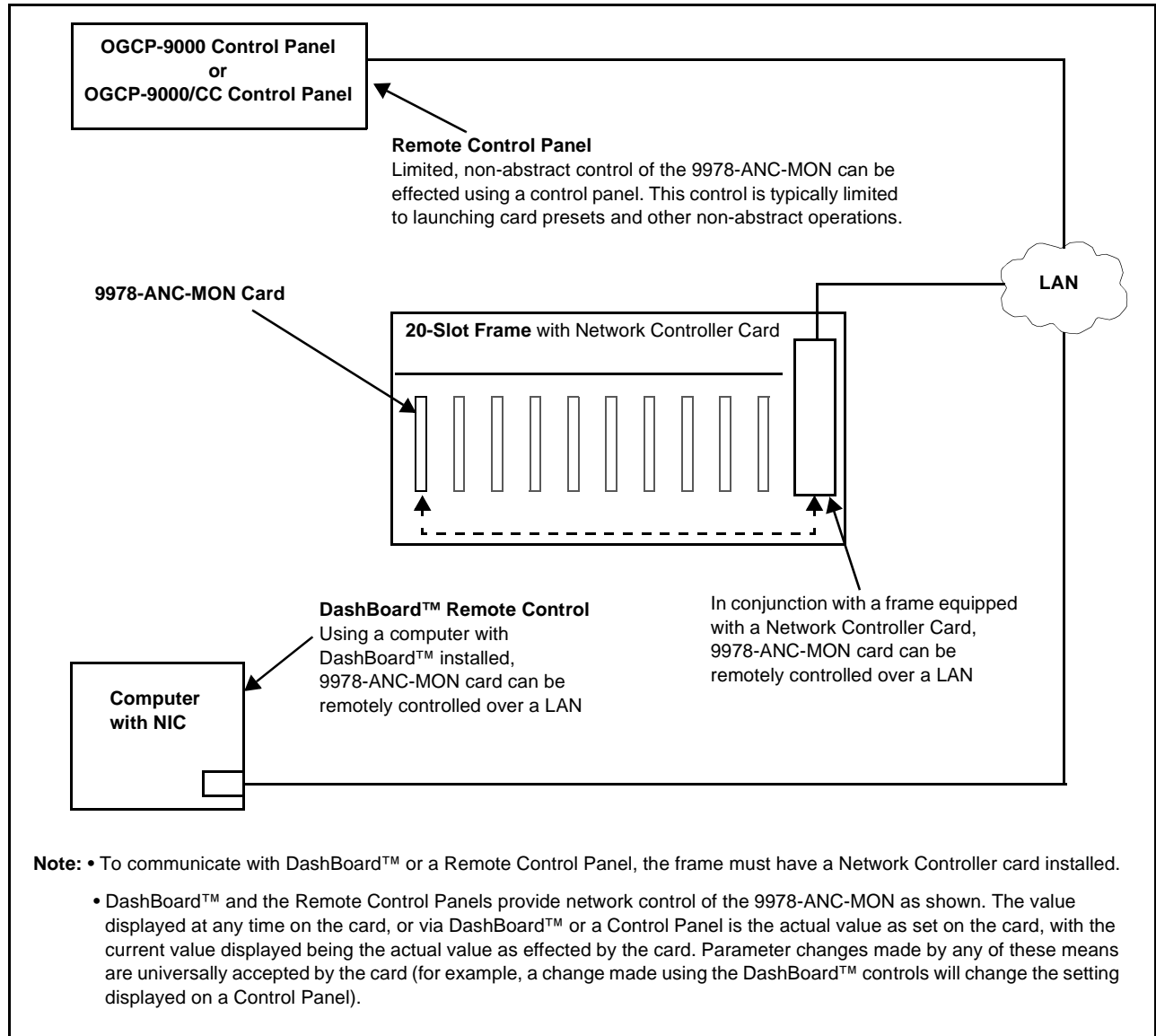

Figure 1-3 9978-ANC-MON User Control Interface

Note: If network remote control is to be used for the frame and the frame has not yet been set up for remote control, Cobalt® reference guide **Remote Control User Guide (PN 9000RCS-RM)** provides thorough information and step-by-step instructions for setting up network remote control of Cobalt® cards using Dashboard™. (Cobalt® OGCP-9000 and OGCP-9000/CC Remote Control Panel product manuals have complete instructions for setting up remote control using a Remote Control Panel.)

Download a copy of this guide by clicking on the **Support>Reference Documents** link at www.cobaltdigital.com and then select Dashboard Remote Control Setup Guide as a download, or contact Cobalt® as listed in Contact Cobalt Digital Inc. (p. 1-13).

9978-ANC-MON Rear I/O Modules

The 9978-ANC-MON physically interfaces to system video connections at the rear of its frame using a Rear I/O Module. All inputs and outputs shown in the 9978-ANC-MON Functional Block Diagram (Figure 1-2) enter and exit the card via the card edge backplane connector. The Rear I/O Module breaks out the 9978-ANC-MON card edge connections to BNC and other connectors that interface with other components and systems in the signal chain. The full assortment of 9978-ANC-MON Rear I/O Modules is shown and described in 9978-ANC-MON Rear I/O Modules (p. 2-4) in Chapter 2, “Installation and Setup”.

Technical Specifications

Table 1-1 lists the technical specifications for the 9978-ANC-MON 3G/HD/SD-SDI Ancillary Data Monitoring Probe with Multiple-Protocol Data Payload SDI/HDMI Display and Fault Detection/Forwarding card.

Table 1-1 Technical Specifications

Item	Characteristic
Part number, nomenclature	9978-ANC-MON 3G/HD/SD-SDI Ancillary Data Monitoring Probe with Multiple-Protocol Data Payload SDI/HDMI Display and Fault Detection/Forwarding
Installation/usage environment	Intended for installation and usage in frame meeting openGear™ modular system definition
Power consumption	< 18 Watts maximum
Installation Density	Up to 20 cards per 20-slot frame
Environmental: Operating temperature: Relative humidity (operating or storage):	32° – 104° F (0° – 40° C) < 95%, non-condensing
Frame communication	10/100/1000 Mbps Ethernet with Auto-MDIX
Indicators	Card edge display and indicators as follows: <ul style="list-style-type: none"> • 4-character alphanumeric display • Status/Error LED indicator • Input Format LED indicator
Program Video Input	Five video inputs; 3G/HD/SD-SDI Data Rates Supported: SMPTE 424M, 292M, SMPTE 259M Impedance: 75 Ω terminating Receive Cable Length: 3G/HD/SD-SDI: 120/180/320 m (Belden 1694A) Return Loss (SDI): > 15 dB up to 1.485 GHz > 10 dB up to 2.970 GHz

Table 1-1 Technical Specifications — continued

Item	Characteristic
Serial Digital Video Output	Number of Outputs: Two 3G/HD/SD-SDI BNC Impedance: 75 Ω Return Loss: > 15 dB at 5 MHz – 270 MHz Signal Level: 800 mV ± 10% DC Offset: 0 V ± 50 mV Jitter (3G/HD/SD): < 0.3/0.2/0.2 UI
HDMI Video Output	HDMI CEA-861D
Frame Reference Input	Number of Inputs: Two non-terminating (looping) Frame Reference inputs with selectable failover Standards Supported: SMPTE 170M/318M (“black burst”) SMPTE 274M/296M (“tri-level”) Return Loss: > 35 dB up to 5.75 MHz

Contact Cobalt Digital Inc.

Feel free to contact our thorough and professional support representatives for any of the following:

- Name and address of your local dealer
- Product information and pricing
- Technical support
- Upcoming trade show information

Phone:	(217) 344-1243
Fax:	(217) 344-1245
Web:	www.cobaltdigital.com
General Information:	info@cobaltdigital.com
Technical Support:	support@cobaltdigital.com

Warranty and Service Information

Cobalt Digital Inc. Limited Warranty

This product is warranted to be free from defects in material and workmanship for a period of five (5) years from the date of shipment to the original purchaser, except that 4000, 5000, 6000, 8000 series power supplies, and Dolby® modules (where applicable) are warranted to be free from defects in material and workmanship for a period of one (1) year.

Cobalt Digital Inc.'s ("Cobalt") sole obligation under this warranty shall be limited to, at its option, (i) the repair or (ii) replacement of the product, and the determination of whether a defect is covered under this limited warranty shall be made at the sole discretion of Cobalt.

This limited warranty applies only to the original end-purchaser of the product, and is not assignable or transferrable therefrom. This warranty is limited to defects in material and workmanship, and shall not apply to acts of God, accidents, or negligence on behalf of the purchaser, and shall be voided upon the misuse, abuse, alteration, or modification of the product. Only Cobalt authorized factory representatives are authorized to make repairs to the product, and any unauthorized attempt to repair this product shall immediately void the warranty. Please contact Cobalt Technical Support for more information.

To facilitate the resolution of warranty related issues, Cobalt recommends registering the product by completing and returning a product registration form. In the event of a warrantable defect, the purchaser shall notify Cobalt with a description of the problem, and Cobalt shall provide the purchaser with a Return Material Authorization ("RMA"). For return, defective products should be double boxed, and sufficiently protected, in the original packaging, or equivalent, and shipped to the Cobalt Factory Service Center, postage prepaid and insured for the purchase price. The purchaser should include the RMA number, description of the problem encountered, date purchased, name of dealer purchased from, and serial number with the shipment.

Cobalt Digital Inc. Factory Service Center

2506 Galen Drive

Champaign, IL 61821 USA

www.cobaltdigital.com

Office: (217) 344-1243

Fax: (217) 344-1245

Email: info@cobaltdigital.com

THIS LIMITED WARRANTY IS EXPRESSLY IN LIEU OF ALL OTHER WARRANTIES EXPRESSED OR IMPLIED, INCLUDING THE WARRANTIES OF MERCHANTABILITY AND FITNESS FOR A PARTICULAR PURPOSE AND OF ALL OTHER OBLIGATIONS OR LIABILITIES ON COBALT'S PART. ANY SOFTWARE PROVIDED WITH, OR FOR USE WITH, THE PRODUCT IS PROVIDED "AS IS." THE BUYER OF THE PRODUCT ACKNOWLEDGES THAT NO OTHER REPRESENTATIONS WERE MADE OR RELIED UPON WITH RESPECT TO THE QUALITY AND FUNCTION OF THE GOODS HEREIN SOLD. COBALT PRODUCTS ARE NOT AUTHORIZED FOR USE IN LIFE SUPPORT APPLICATIONS.

COBALT'S LIABILITY, WHETHER IN CONTRACT, TORT, WARRANTY, OR OTHERWISE, IS LIMITED TO THE REPAIR OR REPLACEMENT, AT ITS OPTION, OF ANY DEFECTIVE PRODUCT, AND SHALL IN NO EVENT INCLUDE SPECIAL, INDIRECT, INCIDENTAL, OR CONSEQUENTIAL DAMAGES (INCLUDING LOST PROFITS), EVEN IF IT HAS BEEN ADVISED OF THE POSSIBILITY OF SUCH DAMAGES.

Installation

Overview

This chapter contains the following information:

- Installing the 9978-ANC-MON Into a Frame Slot (p. 2-1)
- Installing a Rear I/O Module (p. 2-3)
- Setting Up 9978-ANC-MON Network Remote Control (p. 2-8)

Installing the 9978-ANC-MON Into a Frame Slot

CAUTION

Heat and power distribution requirements within a frame may dictate specific slot placement of cards. Cards with many heat-producing components should be arranged to avoid areas of excess heat build-up, particularly in frames using only convection cooling. The 9978-ANC-MON has a moderate power dissipation (<18 W). As such, avoiding placing the card adjacent to other cards with similar dissipation values if possible.

CAUTION



This device contains semiconductor devices which are susceptible to serious damage from Electrostatic Discharge (ESD). ESD damage may not be immediately apparent and can affect the long-term reliability of the device.

Avoid handling circuit boards in high static environments such as carpeted areas, and when wearing synthetic fiber clothing. Always use proper ESD handling precautions and equipment when working on circuit boards and related equipment.

Note: If installing the 9978-ANC-MON in a slot with no rear I/O module, a Rear I/O Module is required before cabling can be connected. Refer to Installing a Rear I/O Module (p. 2-3) for rear I/O module installation procedure.

CAUTION

If required, make certain Rear I/O Module(s) is installed before installing the 9978-ANC-MON into the frame slot. Damage to card and/or Rear I/O Module can occur if module installation is attempted with card already installed in slot.

Note: Check the packaging in which the 9978-ANC-MON was shipped for any extra items such as a Rear I/O Module connection label. In some cases, this label is shipped with the card and to be installed on the Rear I/O connector bank corresponding to the slot location of the card.

Install the 9978-ANC-MON into a frame slot as follows:

1. Determine the slot in which the 9978-ANC-MON is to be installed.
2. Open the frame front access panel.
3. While holding the card by the card edges, align the card such that the plastic ejector tab is on the bottom.
4. Align the card with the top and bottom guides of the slot in which the card is being installed.
5. Gradually slide the card into the slot. When resistance is noticed, gently continue pushing the card until its rear printed circuit edge terminals engage fully into the rear I/O module mating connector.

CAUTION

If card resists fully engaging in rear I/O module mating connector, check for alignment and proper insertion in slot tracks. Damage to card and/or rear I/O module may occur if improper card insertion is attempted.

6. Verify that the card is fully engaged in rear I/O module mating connector.
7. Close the frame front access panel.
8. Connect the input and output cables as shown in 9978-ANC-MON Rear I/O Modules (p. 2-4).
9. Repeat steps 1 through 8 for other 9978-ANC-MON cards.

- Note:**
- The 9978-ANC-MON BNC inputs are internally 75-ohm terminated. It is not necessary to terminate unused BNC inputs or outputs.
 - External frame sync reference signals are received by the card over a reference bus on the card frame, and not on any card rear I/O module connectors. The frame has BNC connectors labeled **REF 1** and **REF 2** which receive the reference signal from an external source such as a house distribution.
 - To remove a card, press down on the ejector tab to unseat the card from the rear I/O module mating connector. Evenly draw the card from its slot.
10. If network remote control is to be used for the frame and the frame has not yet been set up for remote control, perform setup in accordance with Setting Up 9978-ANC-MON Network Remote Control (p. 2-8).

Note: If installing a card in a frame already equipped for, and connected to DashBoard™, no network setup is required for the card. The card will be discovered by DashBoard™ and be ready for use.

Installing a Rear I/O Module

Note: This procedure is applicable **only if a Rear I/O Module is not currently installed** in the slot where the 9978-ANC-MON is to be installed.
If installing the 9978-ANC-MON in a slot already equipped with a suitable I/O module, omit this procedure.

Install a Rear I/O Module as follows:

1. On the frame, determine the slot in which the 9978-ANC-MON is to be installed.
2. In the mounting area corresponding to the slot location, install Rear I/O Module as shown in Figure 2-1.

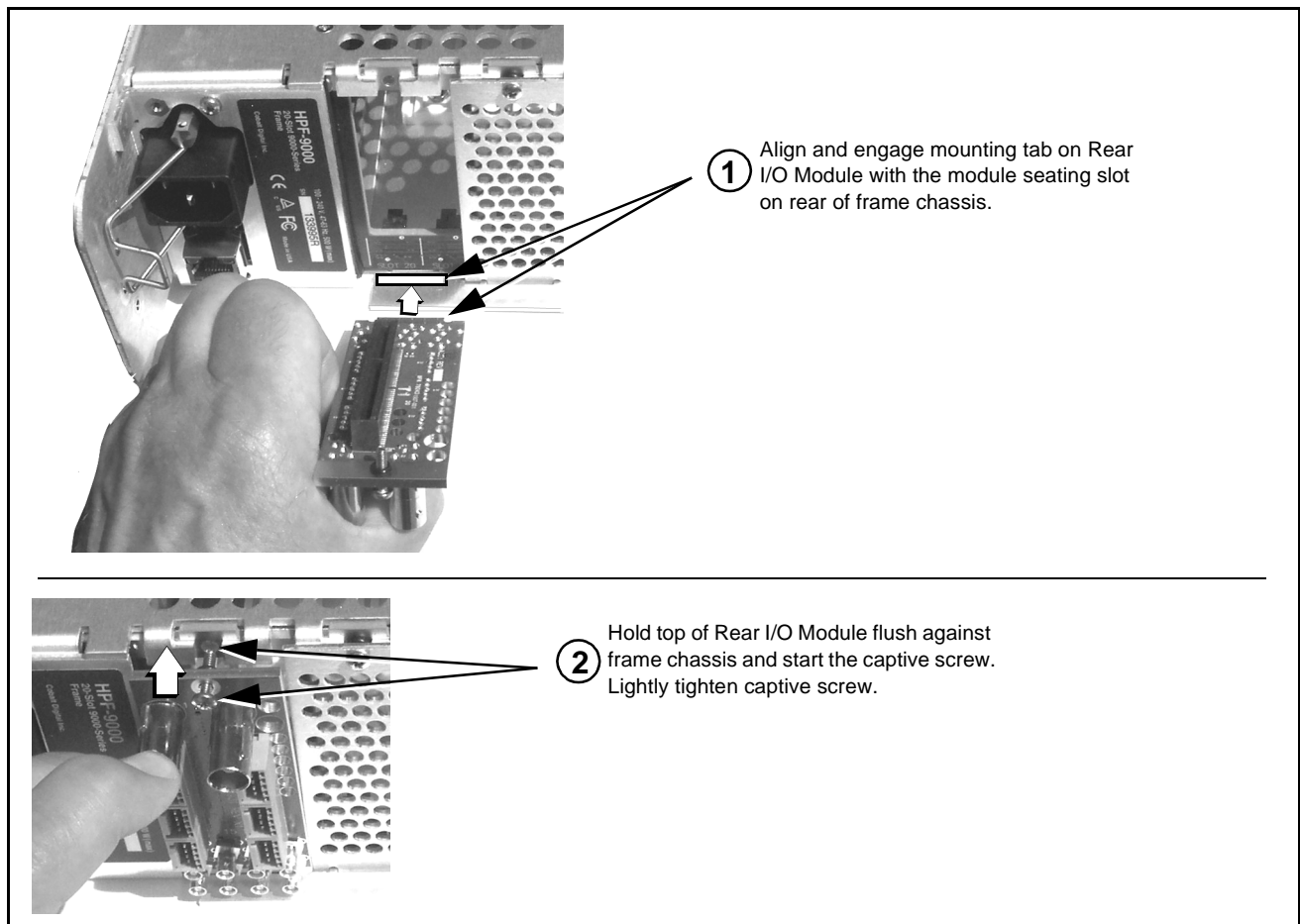

Figure 2-1 Rear I/O Module Installation

9978-ANC-MON Rear I/O Modules

Table 2-1 shows and describes the full assortment of Rear I/O Modules specifically for use with the 9978-ANC-MON.

Table 2-1 9978-ANC-MON Rear I/O Modules

9978-ANC-MON Rear I/O Module	Description
<p>Note: Some rear modules may show COMM/GPIO connections/ports. While present on the rear module(s), these connection are currently reserved and NC.</p>	
<p>RM20-9978-A/S</p> 	<p>Split Rear Module. Provides each of the following connections for two 9978 cards:</p> <ul style="list-style-type: none"> • Two 3G/HD/SD-SDI coaxial input BNCs (SDI IN A and SDI IN C) • Three 3G/HD/SD-SDI Video Out BNCs (SDI OUT 1 thru SDI OUT 3)
<p>RM20-9978-B</p>  <p>9 - UARTA TX 8 - UARTA RX 7 - GND 6 - GPI IN1 5 - GPI IN 2 4 - GND 3 - GPO OUT 1 2 - GPO OUT 2 1 - GPO RTN</p>	<p>Provides the following connections:</p> <ul style="list-style-type: none"> • Four Video In BNCs (VID IN A thru VID IN D) • Two 3G/HD/SD-SDI Combined Video Out BNCs (SDI OUT 1 and SDI OUT 2) • ETHERNET 10/100 connector (reserved) <p>Note: Ethernet connector is reserved for special functions. This port is independent of card/frame network remote control.</p>

Table 2-1 9978-ANC-MON Rear I/O Modules — continued

9978-ANC-MON Rear I/O Module	Description
<p>RM20-9978-C</p>  <p>COMM / GPIO PINOUTS</p> <ul style="list-style-type: none"> 1 - *COM A_RX2 / 422(+) 2 - *COM A_TX2 / 422(+) 3 - COM B_RX2 / 422(+) 4 - GPO OUT1 5 - GND 6 - *COM A_RX1 / 422(-) 7 - *COM A_TX1 / 422(-) 8 - COM B_RX1 / 422(-) 9 - GPI IN5 / GPO OUT 2 10 - GPI IN4 11 - GPI IN1 12 - GPI IN2 13 - GPI IN3 14 - NC 15 - NC <p>* Port can be GUI-configured as two RS-232 ports (Tx and Rx), or as a full-duplex RS-422 port.</p>	<ul style="list-style-type: none"> • Five Video In (VID IN A thru VID IN E) • Two 3G/HD/SD-SDI Combined Video Out (SDI OUT 1 and SDI OUT 2) • ETHERNET 10/100 connector (reserved) • HDMI OUT connector <p>Note: • Ethernet connector is reserved for special functions. This port is independent of card/frame network remote control.</p> <ul style="list-style-type: none"> • Available equipped with High-Density BNC (HDBNC) or DIN1.0/2.3 connectors as: RM20-9978-C-HDBNC or RM20-9978-C-DIN, respectively.
<p>RM20-9978-D</p>  <p>COMM / GPIO PINOUT</p> <ul style="list-style-type: none"> 1 - *COM A_RX2 / 422(+) 2 - *COM A_TX2 / 422(+) 3 - COM B_RX2 / 422(+) 4 - GPO OUT1 5 - GND 6 - *COM A_RX1 / 422(-) 7 - *COM A_TX1 / 422(-) 8 - COM B_RX1 / 422(-) 9 - GPI IN5 / GPO OUT 2 10 - GPI IN4 11 - GPI IN1 12 - GPI IN2 13 - GPI IN3 14 - NC 15 - NC <p>* Port can be GUI-configured as two RS-232 ports (Tx and Rx), or as a full-duplex RS-422 port.</p>	<ul style="list-style-type: none"> • Five Video In (VID IN A thru VID IN E) BNCs • One 3G/HD/SD-SDI Combined Video Out BNC (SDI OUT A) • ETHERNET 10/100 connector (reserved) <p>Note: Ethernet connector is reserved for special functions. This port is independent of card/frame network remote control.</p>

Table 2-1 9978-ANC-MON Rear I/O Modules — continued

9978-ANC-MON Rear I/O Module	Description
<p>RM20-9978-E</p>  <p>Note: RLY BYP B is a relay-protected path which carries processed SDI out under normal conditions and passive routes SDI IN B to this BNC upon loss of power.</p>	<ul style="list-style-type: none"> • Four Video In (SDI IN A thru SDI IN D) • Two 3G/HD/SD-SDI PiP Combined Video Out (SDI OUT 1 and SDI OUT 2) • Relay bypass protected cascade path out SDI OUT 1 (Relay bypass provides passive input to SDI output upon card removal or loss of power.)
<p>RM20-9978-F</p>  <p>Note: RLY BYP B is the card processed output which uses either input SDI IN A or SDI IN B. This output uses relay latching to retain selected routing in the event of power loss regardless of whether a selection was manually invoked or by a unit-detected failover (for example, if an auto-changeover from A to B was invoked while active, routing of input B to this output is retained in the event of power loss).</p>	<ul style="list-style-type: none"> • Two Video In (SDI IN A and SDI IN B) • One 3G/HD/SD-SDI PiP Combined Video Out (SDI OUT 1) • Relay bypass protected cascade path out SDI OUT 2 (Relay bypass provides passive input to SDI output upon card removal or loss of power.)

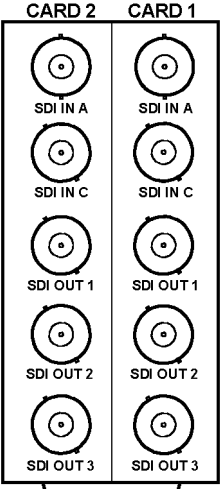
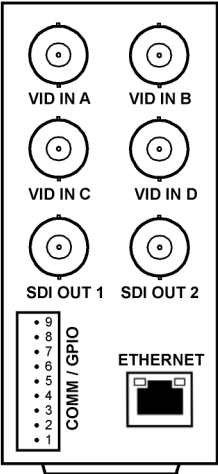
Table 2-1 9978-ANC-MON Rear I/O Modules — continued

9978-ANC-MON Rear I/O Module	Description
<p>RM20-9978-G/S</p> 	<p>Split Rear Module. Provides each of the following connections for two 9978 cards:</p> <ul style="list-style-type: none"> • Four Video In (SDI IN A thru SDI IN D) • Two 3G/HD/SD-SDI Combined Video Out (SDI OUT 1 and SDI OUT 2) <p>Note: Available equipped with High-Density BNC (HDBNC) or DIN1.0/2.3 connectors as: RM20-9978-G/S-HDBNC or RM20-9978-G/S-DIN, respectively.</p>
<p>RM20-9978-H</p>  <p>COMM / GPIO</p> <ol style="list-style-type: none"> 1 - *COM A_RX2 / 422(+) 2 - *COM A_TX2 / 422(+) 3 - COM B_RX2 / 422(+) 4 - GPO OUT1 5 - GND 6 - *COM A_RX1 / 422(-) 7 - *COM A_TX1 / 422(-) 8 - COM B_RX1 / 422(-) 9 - GPI IN5 / GPO OUT 2 10 - GPI IN4 11 - GPI IN1 12 - GPI IN2 13 - GPI IN3 14 - NC 15 - NC <p>* Port can be GUI-configured as two RS-232 ports (Tx and Rx), or as a full-duplex RS-422 port.</p>	<ul style="list-style-type: none"> • Four Video In (VID IN A thru VID IN D) • Relay bypass protected input (VID IN E) • Two 3G/HD/SD-SDI PiP Combined Video Out (SDI OUT 1A and SDI OUT 2A) • Relay bypass protected path out SDI OUT 1B (Relay bypass provides passive VID IN E input to SDI output upon card removal or loss of power.) • ETHERNET 10/100 connector (reserved) • HDMI OUT connector <p>Note:</p> <ul style="list-style-type: none"> • Ethernet connector is reserved for special functions. This port is independent of card/frame network remote control. • Available equipped with High-Density BNC (HDBNC) or DIN1.0/2.3 connectors as: RM20-9978-H-HDBNC or RM20-9978-H-DIN, respectively.

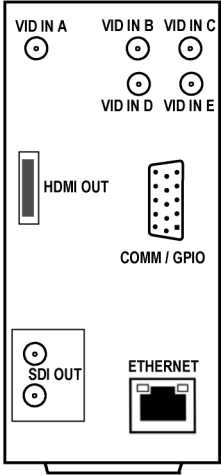
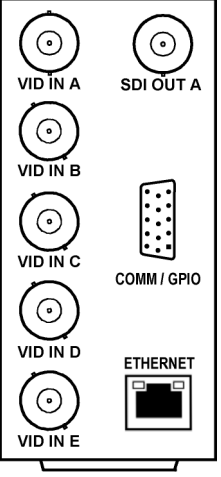
Setting Up 9978-ANC-MON Network Remote Control

Perform remote control setup in accordance with Cobalt® reference guide “Remote Control User Guide” (PN 9000RCS-RM).

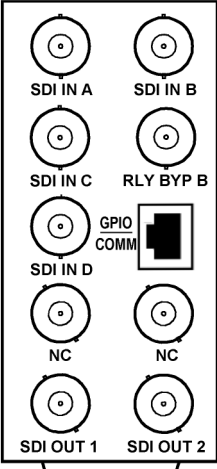
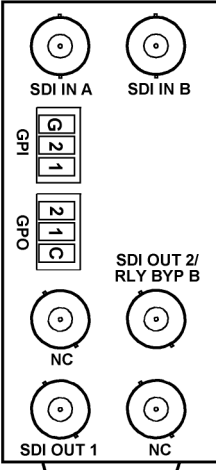
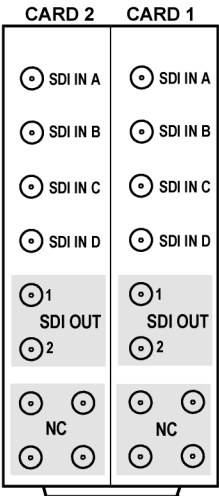
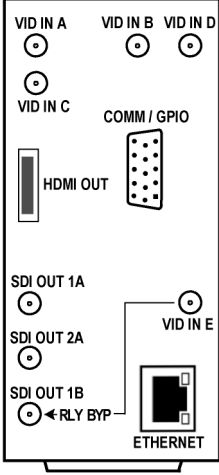
- Note:**
- If network remote control is to be used for the frame and the frame has not yet been set up for remote control, Cobalt® reference guide **Remote Control User Guide (PN 9000RCS-RM)** provides thorough information and step-by-step instructions for setting up network remote control of Cobalt® cards using DashBoard™. (Cobalt® OGCP-9000 and/or OGCP-9000/CC Remote Control Panels are not recommended for use with this product.)
Download a copy of this guide by clicking on the **Support > Reference Documents** link at www.cobaltdigital.com and then select DashBoard Remote Control Setup Guide as a download, or contact Cobalt® as listed in Contact Cobalt Digital Inc. (p. 1-13).
 - If installing a card in a frame already equipped for, and connected to DashBoard™, no network setup is required for the card. The card will be discovered by DashBoard™ and be ready for use.
 - This card requires DashBoard™ version 6.0 or greater for full monitoring and control (as shown in this manual). This is due to the added user interface controls which can only be accommodated with DashBoard version 6.0 or greater. While cards with the firmware version 1.62.000 (or later) will appear in the frame Basic Tree View in earlier DashBoard versions, many card controls will not be accessible. For a free download of the latest DashBoard version, please go to www.cobaltdigital.com, and select **Products > Software Control > DashBoard™**, and then select the version applicable to your computer.

Operating Instructions

Overview

If you are already familiar with using DashBoard to control Cobalt cards, please skip to Overview of Status Displays on Output Video (p. 3-7).

This chapter contains the following information:

- Control and Display Descriptions (p. 3-1)
- Accessing the 9978-ANC-MON Card via Remote Control (p. 3-4)
- Checking 9978-ANC-MON Card Information (p. 3-6)
- Overview of Status Displays on Output Video (p. 3-7)
- Overview of Setting Up Images and Status Fields on Output Raster (p. 3-7)
- 9978-ANC-MON Function Menu List and Descriptions (p. 3-9)
- Troubleshooting (p. 3-32)

Control and Display Descriptions

This section describes the user interface controls, indicators, and displays for using the 9978-ANC-MON card.

Access to the 9978-ANC-MON functions (and the controls, indicators, and displays related to a particular function) follows a general arrangement of Function Menus under which related controls can be accessed (as described in Function Menu/Parameter Menu Overview below).

Note: When a setting is changed, settings displayed on DashBoard™ are the settings as effected by the card itself and reported back to the remote control; the value displayed at any time is the actual value as set on the card.

Function Menu/Parameter Menu Overview

The functions and related parameters available on the 9978-ANC-MON card are organized into function **menus**, which consist of parameter groups as shown below.

Figure 3-1 shows how the 9978-ANC-MON card and its menus are organized, and also provides an overview of how navigation is performed between cards, function menus, and parameters.

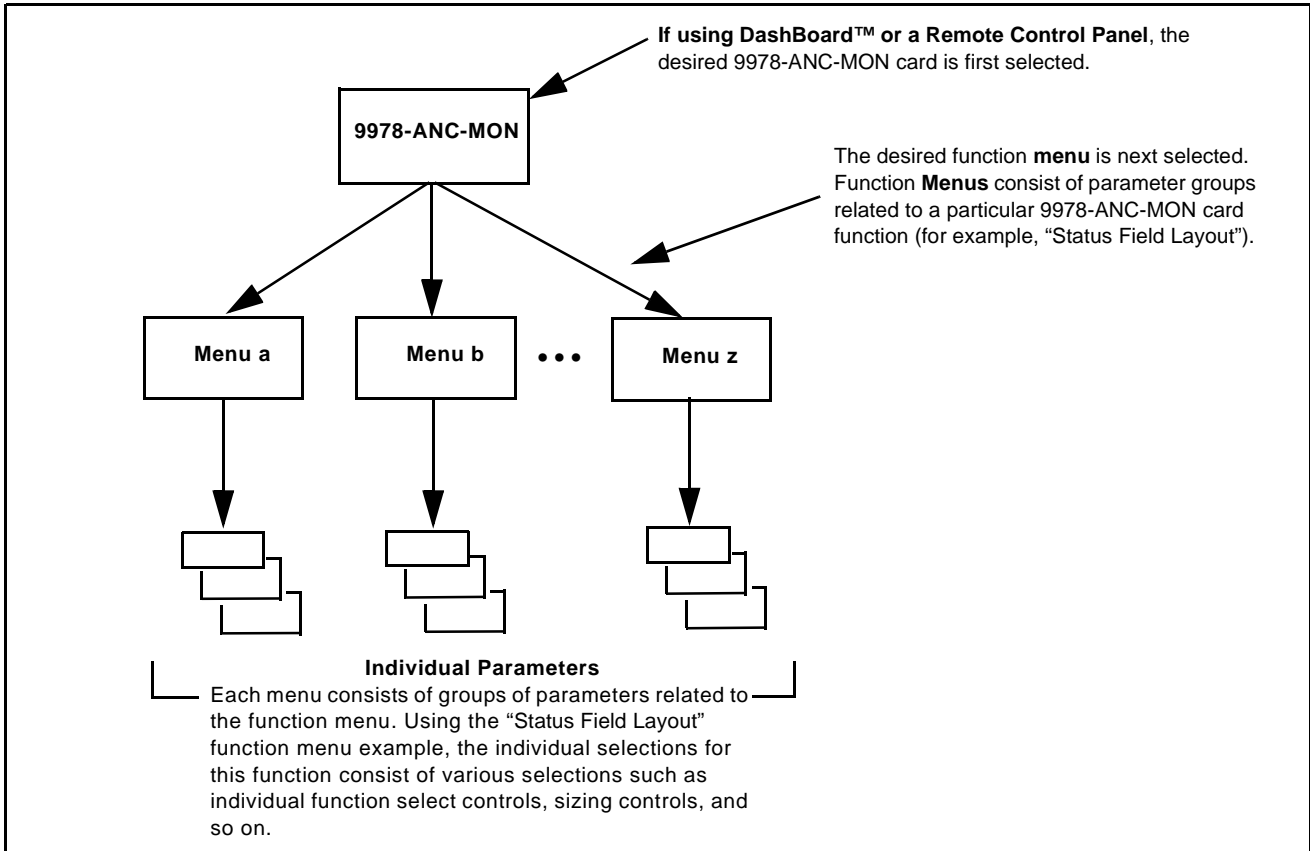

Figure 3-1 Function Menu/Parameter Menu Overview

DashBoard™ User Interface

(See Figure 3-2.) The card function menus are organized in DashBoard™ using tabs. When a tab is selected, each parametric control or selection list item associated with the function is displayed. Scalar (numeric) parametric values can then be adjusted as desired using the GUI slider controls. Items in a list can then be selected using GUI drop-down lists.

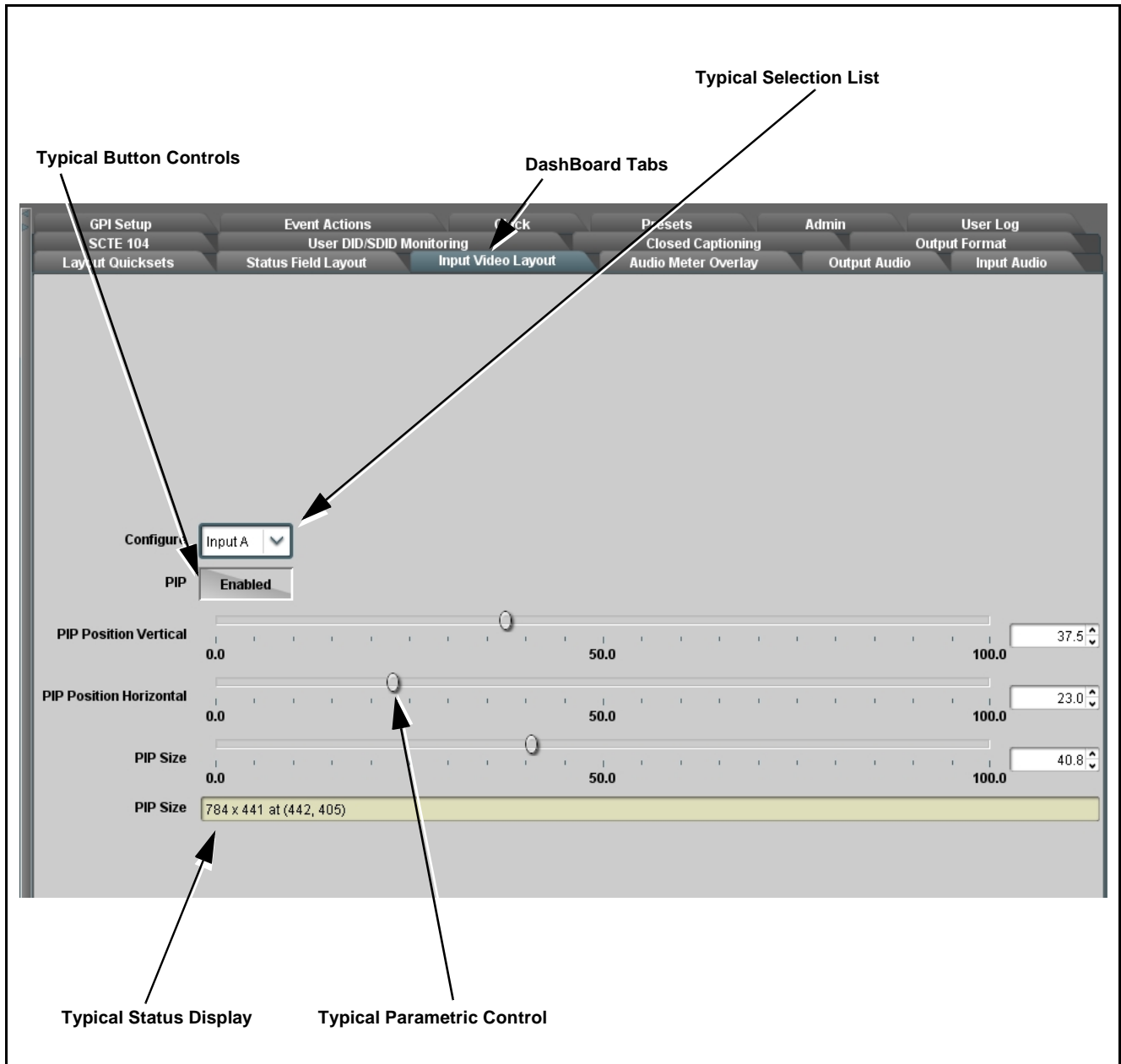

Figure 3-2 Typical DashBoard Tabs and Controls

Accessing the 9978-ANC-MON Card via Remote Control

Access the 9978-ANC-MON card using DashBoard™ or Cobalt® Remote Control Panel as described below.

Accessing the 9978-ANC-MON Card Using DashBoard™

1. On the computer connected to the frame LAN, open DashBoard™.
2. As shown below, in the left side Basic View Tree locate the Network Controller Card associated with the frame containing the 9978-ANC-MON card to be accessed (in this example, “MFC-8320-N SN: 00108053”).

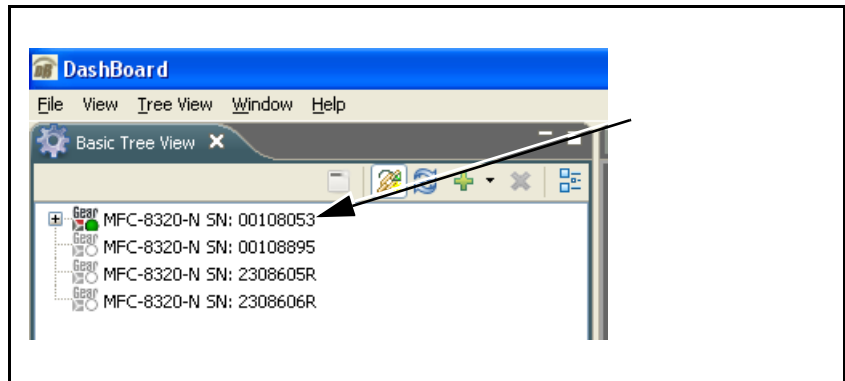

3. As shown below, expand the tree to access the cards within the frame. Click on the card to be accessed (in this example, “Slot 6: 9978-ANC-MON”).

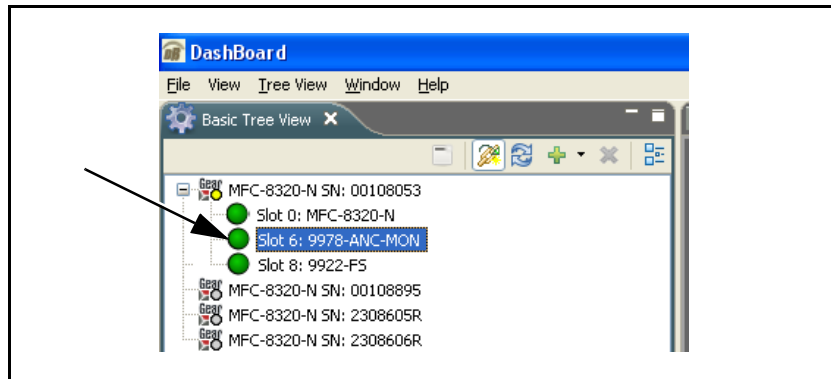

As shown on the next page, when the card is accessed in DashBoard™ its function menu screen showing tabs for each function is displayed. (The particular menu screen displayed is the previously displayed screen from the last time the card was accessed by DashBoard™).

Card Access/Navigation Tree Pane

- Device Configuration Files
 - 88G-1078-ANC-MON
 - Cloverleaf Cards
 - cobaltcom
 - Frame
 - Frame 01a7ff-0000007d
 - Frame185
 - HPF-9000_SW-A
 - HPF-9000_SW-B
 - HPF-9000_SW-C
 - HPF-9000_SW-D
 - Slot 0: HPF-FC
 - Slot 2: 9223-D-HD-P
 - Slot 4: 9990-DEC-MPEG
 - Slot 6: 9978-ANC-MON

Card Info Pane

Slot 6: 9978-ANC-MON

Card state: ● OK

Connection: ● ONLINE

Status	Product Info
Output Video	1080p 59.94
Input A	● 720p 59.94, OK Time 0:23:48, 0 E
Input B	● 1080i 59.94, OK Time 0:24:44, 0 E
Input C	● 1080p 59.94, OK Time 0:24:44, 0 E
Input D	● No Input
Input E	● No Input
Reference	● 525i 59.94, OK Time 0:24:03 (Ref)
Card Voltage	11.98 V
Card Power	13.62 W
Card Temp Front	24.3 C
Card Temp Rear	37.6 C
Card Temp FPGA	41.3 C amb 49.0 C core
Card Up Time	00:24:25
Card Active IP	192.168.1.104
Preset Engaged	Autosave
Card Time	20:46:36

Card Function Menu and Controls Pane

Element: Status Field 7

Position H: 0.0 to 100.0 (Slider at 50.0) [23.0]

Position V: 0.0 to 100.0 (Slider at 50.0) [92.2]

Width: 0.0 to 100.0 (Slider at 50.0) [75.0]

Height: 0.0 to 100.0 (Slider at 50.0) [19.0]

Status Field 1	Status Field 2	Status Field 3	Status Field 4	Status Field 5
Source Select: Input A	Source Select: Input A	Source Select: Input A	Source Select: Input A	Source Select: Input A
Status Select: Input Format	Status Select: AFD	Status Select: Audio Presence	Status Select: LKFS	Status Select: Dolby Pair 2
Status Field 6	Status Field 7	Status Field 8	Status Field 9	Status Field 10
Source Select: Input A	Source Select: Input A	Source Select: Input A	Source Select: Input A	Source Select: Input A
Status Select: Clock	Status Select: SCTE104 Log	Status Select: CC Overlay	Status Select: Disabled	Status Select: Disabled
Status Field 11	Status Field 12	Status Field 13	Status Field 14	Status Field 15
Source Select: Input A	Source Select: Input A	Source Select: Input A	Source Select: Input A	Source Select: Input A
Status Select: Disabled	Status Select: Disabled	Status Select: Disabled	Status Select: Disabled	Status Select: Disabled
Input A	Input B	Input C	Input D	Input E
Time Code: Disabled	Time Code: Disabled	Time Code: Disabled	Time Code: Disabled	Time Code: Disabled

Buttons: Refresh, Upload, Reboot, Close

Checking 9978-ANC-MON Card Information

The operating status and software version the 9978-ANC-MON card can be checked using DashBoard™. Figure 3-3 shows and describes the 9978-ANC-MON card information screen using DashBoard™.

Note: Proper operating status in DashBoard™ is denoted by green icons for the status indicators shown in Figure 3-3. Yellow or red icons respectively indicate an alert or failure condition. Refer to Troubleshooting (p. 3-32) for corrective action.

The **Tree View** shows the cards seen by DashBoard™. In this example, Network Controller Card is hosting a 9978-ANC-MON card in slot 6.

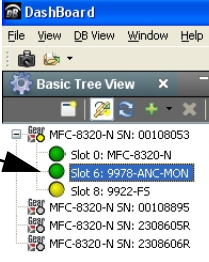

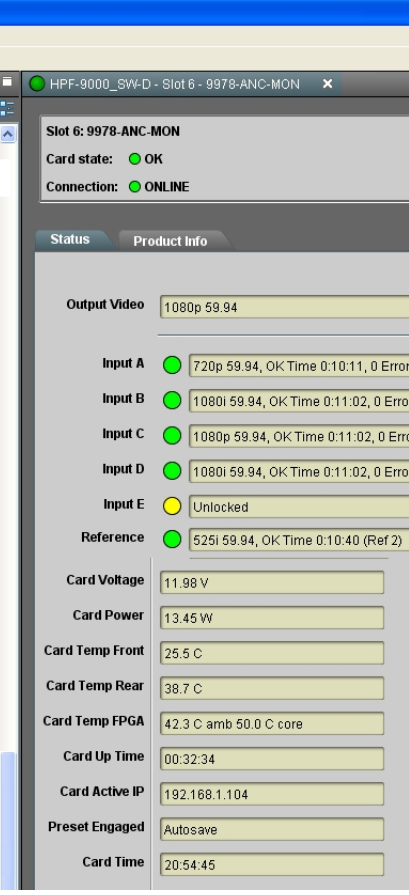

Status Display
This displays shows the status and format of the signals being received by the 9978-ANC-MON, as well as card status.

Card (Product) Info Display
This display (alternately selected in the Product Info pane) shows the the card hardware and software version info, as well as a Cobalt code number for the currently installed rear module.

Status	Product Info
Product	9978-ANC-MON
Supplier	Cobalt Digital Inc.
Revision	1.202.F508-dev
Build Date	Jun 24 2016 10:06:19
FPGA Revision	1.00.0000
FPGA Build Date	Nov 4 2015 23:43:54
Kernel Revision	3.2.0-Local-1.4 #66 Thu Jul 23 17:29:47 CDT
Flash Storage	53.3 MB free
RAM Usage	26.4 %
CPU Usage	00.0 %

Figure 3-3 9978-ANC-MON Card Info/Status Utility

Overview of Status Displays on Output Video

Figure 3-4 shows an example output video view showing four input rasters combined in a user-configured quad multiviewer output format, as well as various Status Field displays positioned around the program images set to monitor various Input Video channels. When a Status Field is set as **Disabled**, the Status Field disappears from the output raster with the background fill taking its place.

Input video raster insertion, sizing and positioning is entirely user-configurable. Sizing and positioning of any status field is also entirely user-configurable.

- For detailed description of Status Field Layout setup see Status Field Layout Controls (p. 3-10)
- For detailed description of Input Video Layout setup see Input Video Layout Controls (p. 3-14)

Overview of Setting Up Images and Status Fields on Output Raster

Because the 9978-ANC-MON allows full flexibility of program video image insertion as well as up to 15 Status Fields (which can be set from numerous choices of data type monitored as well as full flexibility of the input monitored for each Status Display field), the following steps will help in organizing and laying out the overall display to meet your requirements.

Note: The following is a brief overview. Refer to 9978-ANC-MON Function Menu List and Descriptions (p. 3-9) for detailed information about using control to set display attributes.

- Decide which input video channels need to be displayed. For each input channel desired to be displayed, set sizing and positioning as described in Input Video Layout Controls (p. 3-14). It is recommended to size and position image rasters such that room is available for inserting Status Fields without obscuring too much of the image rasters.
- Decide which data types are to be displayed. Using the up to 15 available Status Fields, set each (as needed) to display the data type needed as well as the input channel to which the monitoring is to correlate. If less than all 15 status fields are needed, leaving the unneeded fields set to Disabled removes the field(s) from the raster. Set Status Fields as described in Status Field Layout Controls (p. 3-10).

The steps above describe the basic tasks to set up the card for image and status display. Many other functions are available. Read and understand **all** sections of 9978-ANC-MON Function Menu List and Descriptions (p. 3-9) to fully benefit from all card functions as applicable to your needs.

In this example, four input video rasters are simultaneously displayed. Status Fields 1 thru 9 (of 15 available Status Fields) are enabled for burn-in display. The layout shown here is an example; **any** Input Video **A** thru **E** raster or Status Field **1** thru **15** can be positioned and sized **anywhere** on the output raster as desired.

Many other data types (not shown here) can also be displayed. See Status Field Layout Controls (p. 3-10) for more information.

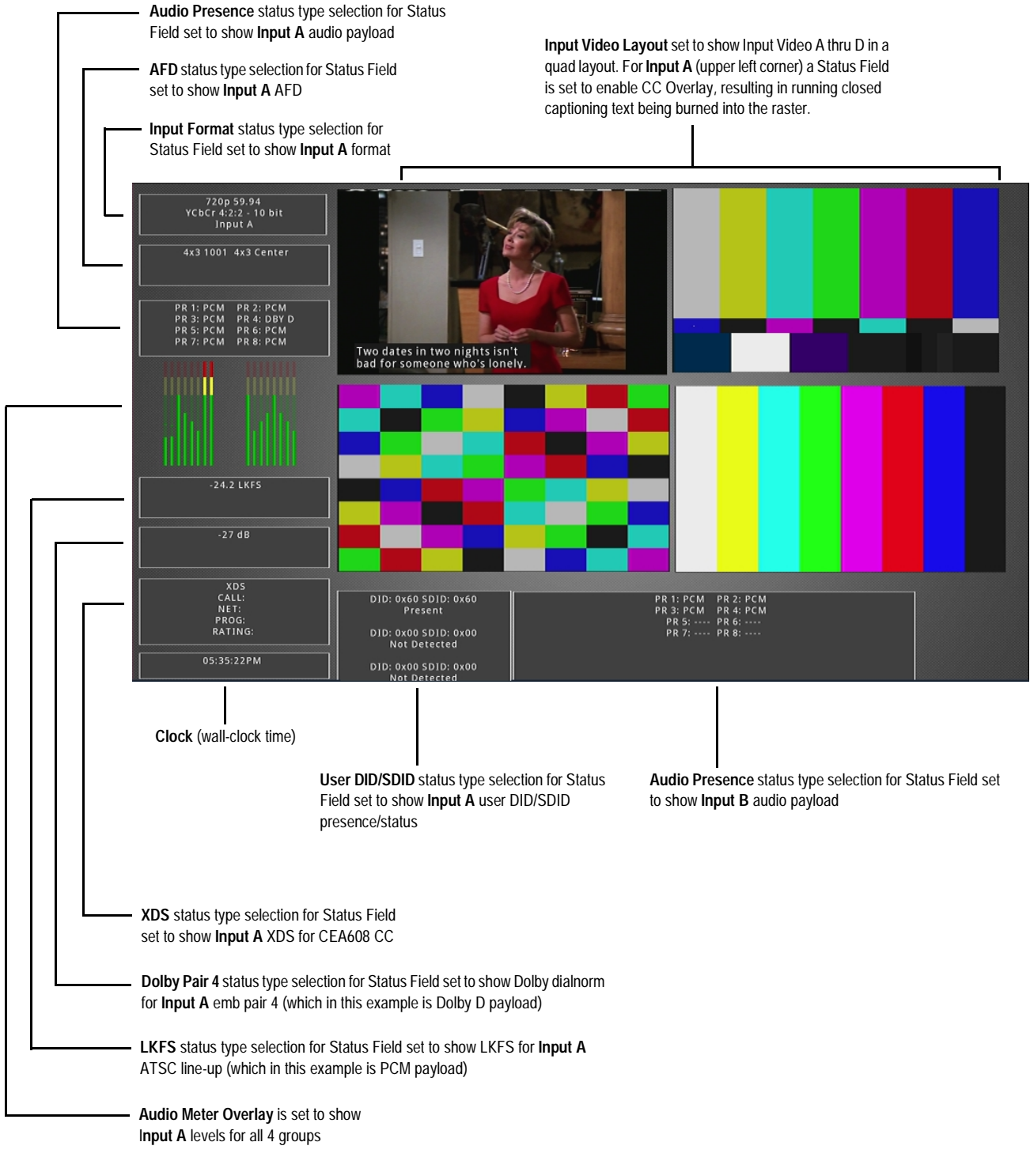



Figure 3-4 Overview of Status Displays on Output Video

9978-ANC-MON Function Menu List and Descriptions

Table 3-1 individually lists and describes each 9978-ANC-MON function menu and its related list selections, controls, and parameters. Where helpful, examples showing usage of a function are also provided. Table 3-1 is primarily based upon using DashBoard™ to access each function and its corresponding menus and parameters.

Note: All numeric (scalar) parameters displayed on DashBoard™ can be changed using the slider controls,  arrows, or by numeric keypad entry in the corresponding numeric field. (When using numeric keypad entry, add a return after the entry to commit the entry.)

On DashBoard™ itself and in Table 3-1, the function menu items are organized using tabs as shown below.

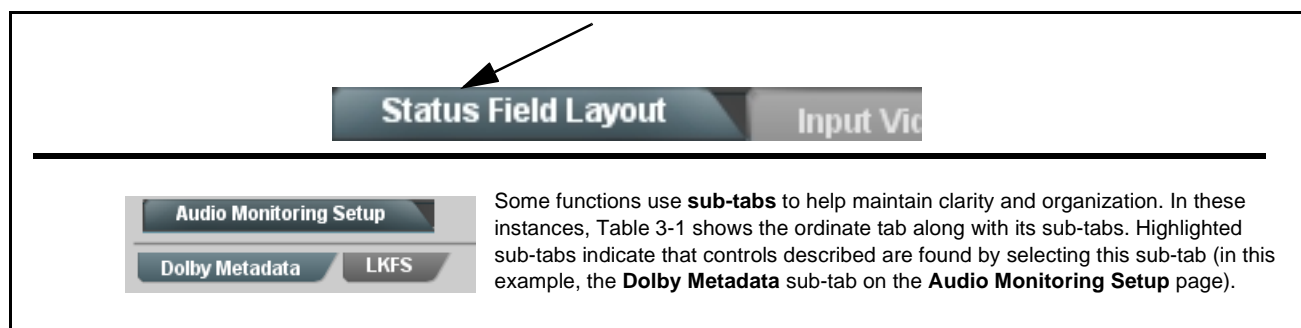

The table below provides a quick-reference to the page numbers where each function menu item can be found.

Function Menu Item	Page	Function Menu Item	Page
Layout Quicksets	3-10	SCTE 104 Status Setup Controls	3-21
Status Field Layout Controls	3-10	User DID/SDID Monitoring Setup Controls	3-22
Input Selection	3-13	Output Format Controls	3-23
Input Video Layout Controls	3-14	Clock (Wall-Clock Time/LTC) Controls	3-25
Audio Meter Overlay Controls	3-15	Presets	3-27
Output Audio Routing/Controls	3-19	Admin	3-29
Audio Monitoring Setup Controls	3-20	User Log	3-32

Table 3-1 9978-ANC-MON Function Menu List



	<p>This tab/page is reserved. Use Status Field Layout Controls and Input Video Layout Controls to perform layouts (see next pages).</p>
	<p>Provides controls for inserting (enabling) up to 15 Status Fields. Provides controls for setting data type monitored/displayed for each status field as well as correlating the status display to an input channel.</p>
<p>Status Fields are enabled and inserted using the Status Field (1 thru 15) drop-downs by:</p> <ul style="list-style-type: none"> • Selecting the data type to be monitored/displayed (Status Select) and correlating the status field to an input video channel to be monitored using the Source Select drop-down selectors. • Sizing and positioning the individual Status Field displays using the Position / Size controls. (see p. 3-13 for details). <p>Example:</p> <ul style="list-style-type: none"> • In this example, Status Field 1 is to be used to show Input Format for card Input A. The Source Select drop-down is set to Input A. The Status Select drop-down is set to Input Format. <div data-bbox="1013 722 1383 877" style="border: 1px solid gray; padding: 5px; margin: 10px 0;"> <p style="text-align: center;">Status Field 1</p> <p>Source Select <input type="text" value="Input A"/> ▼</p> <p>Status Select <input type="text" value="Input Format"/> ▼</p> </div> <ul style="list-style-type: none"> • The Status Field insertion is now active. Using the Position - Size controls, the insertion can be placed anywhere on the output raster as desired (in this example, the status fields are positioned and sized to be placed around the program video PiP insertions). <p>Note: When any Status Field is set to disabled, its data display and background box are removed from raster insertion. Make certain any unused Status fields are set to Disabled so that the unused status fields do not take up any raster area.</p> <div data-bbox="760 911 1403 1268" style="border: 1px solid gray; padding: 5px; margin: 10px 0;">  </div>	
<p>Note: Status Field 1 controls are shown. Identical independent controls are provided for Status Field 2 thru 15. Therefore, only the Status Field 1 controls are shown here.</p>	
<ul style="list-style-type: none"> • Input Video Source Select <div data-bbox="243 1457 630 1709" style="border: 1px solid gray; padding: 5px; margin: 10px 0;"> <p style="text-align: center;">Status Field 1</p> <p>Source Select <input type="text" value="Input A"/> ▼</p> <ul style="list-style-type: none"> Input A Input B Input C Input D Input E </div>	<p>Sets the status field to correlate its monitoring to a desired input video channel (Input A thru Input E).</p>

Table 3-1 9978-ANC-MON Function Menu List — continued



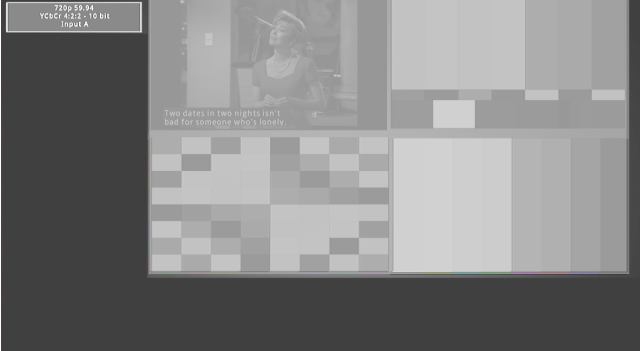

Status Field Layout	(continued)
<p>• Status (Data Type) Select</p> 	<p>Selects the data type monitoring function for the selected Status Field (1 thru 15) from the choices shown and described below.</p> <p>Note: If a status field is not needed to be displayed, use the Disabled choice. When any Status Field is set to disabled, its data display and background box are removed from raster insertion.</p>
<p>•• Input Format Display</p> 	<p>Provides display of input format for the SDI input selected for the status field. Shows raster and frame rate, colorspace/word length, and the input associated with the status field.</p>
<p>•• AFD Display</p> 	<p>Provides display of any AFD coding present for the SDI input selected for the status field. If SDI input does not contain AFD coding, No AFD is displayed.</p>
<p>•• SCTE104 Display</p> 	<p>Provides condensed summary display of last three SCTE 104 messages present for the SDI input selected for the status field. (In this example, splice start normal, splice end normal, and splice cancel messages were received, with time stamps noted for each.)</p> <p>The running time on the last line indicates elapsed time since last messaged received.</p> <p>Note: This status field type is a condensed summary only. Highly detailed message history is available using the SCTE 104 tab. See SCTE 104 Status Setup Controls (p. 3-21) for details.</p>
<p>•• Audio Presence Display</p> 	<p>Provides display of audio payload for all 8 embedded pairs for the SDI input selected for the status field. In the example here, all pairs are PCM except pair 4 which is carrying Dolby D (“DBY D”).</p> <p>If no payload is present, associated pair(s) show blank (“...”).</p>
<p>•• LKFS Display</p> 	<p>Provides display of short-term moving average ATSC A/85 LKFS for the SDI input selected for the status field.</p> <p>Note:</p> <ul style="list-style-type: none"> • Individual channels comprising the LKFS complement and measurement window time are selected using the LKFS subtab on the Input Audio tab/page. See Audio Monitoring Setup Controls (p. 3-20) • LKFS display is intended for use with PCM audio and can only be used with SDI Input A.

Table 3-1 9978-ANC-MON Function Menu List — continued



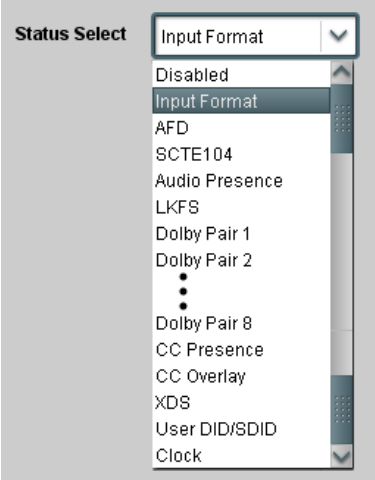

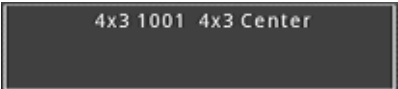
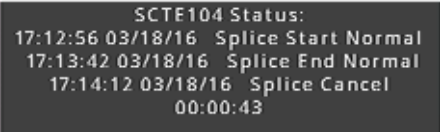
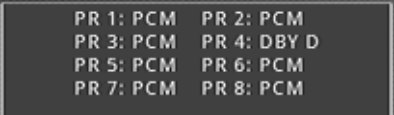
Status Field Layout	(continued)
<p>•• Dolby Pair (1-8) Display</p> 	<p>Provides display of Dolby Dialnorm metadata for the selected embedded channel pair of the SDI input selected for the status field. If pair is not carrying Dolby, "PCM" is displayed.</p>
<p>•• CC Presence Display</p> 	<p>Provides display of CEA608 and CEA708 closed-captioning presence of the SDI input selected for the status field. (In this example, display shows CEA608 service CC1 is detected. If showing all dashes, indicates no services detected.)</p> <p>Note: CC Presence display can only be used with SDI Input A.</p>
<p>•• CC Overlay Display</p> 	<p>Provides running decoded text payload of CEA608 / CEA708 closed-captioning for the SDI input selected for the status field.</p> <p>Note: CC Overlay display can only be used with SDI Input A.</p>
<p>•• XDS Presence Display</p> 	<p>Provides display of CEA608 Extended Data Service (XDS) of the SDI input selected for the status field. If XDS content is not present, blanks are displayed.</p> <p>Note: XDS Presence display can only be used with SDI Input A.</p>
<p>•• User DID/SDID Display</p> 	<p>Provides display of presence of user-specified DID/SDID ANC insertions of the SDI input selected for the status field.</p> <p>Note: User DID/SDID locations are set using the User DID/SDID Monitoring tab/page. See User DID/SDID Monitoring Setup Controls (p. 3-22)</p>
<p>•• Clock Display</p> 	<p>Provides clock display of wall-clock time.</p> <p>Note:</p> <ul style="list-style-type: none"> • Clock display is not associated with Source Select SDI input. For display of this data type, Source Select can be disregarded. • Clock is set and displays time in accordance with clock setting performed using the Clock tab/page. See Clock (Wall-Clock Time/LTC) Controls (p. 3-25)

Table 3-1 9978-ANC-MON Function Menu List — continued



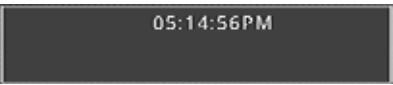

<h3>Status Field Layout</h3>	<p>(continued)</p>
<p>•• Time Code Display</p> 	<p>Provides time code display for the SDI input selected for the status field. Note: Time code must be in the format of ATC_VITC for timecode to be reported. Other formats will show blank.</p>
<h3>Positioning and Sizing Status Fields Within the Output Raster</h3> <p>Each enabled Status Field is positioned one-at-a-time using the shared Position H / Position V and Width / Height controls.</p>	
<p>Sizing and positioning of each Status Field is done individually by selecting the Status Field to be manipulated using the Element > Status Field drop-down.</p> <p>When the field is selected, it can now be sized and positioned using the slider controls.</p>	
<p>Example: First, Status Field 1 (set to display data type Input Format) is enabled. It is sized and positioned to be at the upper LHS of the program image display, bordering the PIP multiviewer program video display.</p> 	<p>Next, Status Field 2 (set to display data type AFD) is enabled. It is sized and positioned to position it directly under Status Field 1.</p> <p>For a layout with status fields wrapping around the program video images, this can be continued for other Status Field insertions similarly.</p> 
<h3>Input Selection</h3>	<p>Select inputs to be applied to be applied to the card.</p>
<p>• PIP Input Source Select</p> 	<p>Routes the card SDI inputs (VID IN A thru VID IN E as In A thru In E, respectively) to the card inputs. (In this example, VID IN A thru VID IN E are respectively routed as PIP 1 thru PIP 5 input sources.)</p> <p>The Audio Output Source selector routes a selected input audio to serve as the audio present on the card SDI output.</p> <p>Note: A CVBS input is automatically detected by the card input, with the CVBS ADC converter automatically engaged.</p>

Table 3-1 9978-ANC-MON Function Menu List — continued

<h2 style="margin: 0;">Input Video Layout</h2>	<p>Provides controls for sizing and positioning up to five input video program video PiPs within the output raster.</p>
<p>Input video insertions are enabled using the Configure drop-down and setting PIP to Enabled.</p> <p>Note: When any input video PIP is set to disabled, the raster is not inserted into the output video image (although “unviewed” inputs can still be monitored as desired using the Status Field Layout Controls (p. 3-10)). Make certain any unused inputs or inputs not to be displayed are set to Disabled so that the unused image area doesn’t take up any raster area.</p>	
<p>Positioning and Sizing Program Video PiPs Within the Output Raster</p>	
<p>Each enabled input video PiP is positioned one-at-a-time using the shared PIP Position (V, H) and PIP Size controls.</p>	
<p>Insertion, sizing and positioning of each PiP is done individually by selecting the Input to be manipulated using the Configure drop-down and setting PIP to Enabled.</p>	
<p>When the input is selected and enabled, it can now be sized and positioned using the slider controls.</p>	
<p>Current Location display shows the user-configured PiP size and x,y origin coordinates</p>	
<p>Example (Quad-Split Layout):</p>	
<p>First, Input A is enabled and inserted. It is sized and positioned (using the controls described above) to be at the upper LHS of the image space raster.</p>	
<p>Next, Input B is enabled and inserted (Configure > Input B). It is sized and positioned (using the controls described above) to position it directly under the Input A raster.</p>	
<p>Finally, Inputs C and D (one-by-one) are enabled and inserted. They are sized and positioned to be to right of Inputs A and B.</p>	

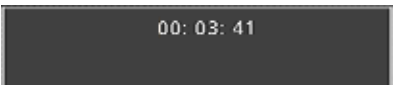
Table 3-1 9978-ANC-MON Function Menu List — continued

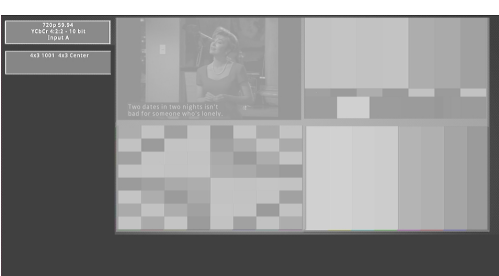
	<p>Provides controls for each SDI input to insert active-video area audio meters (bars), and set insertion rules and attributes such as layout, size and position.</p>
<p>Note:</p> <ul style="list-style-type: none"> • Audio meters are correlated with the embedded audio associated only with each respective SDI input. A contiguous group of bars cannot display levels sourced from multiple inputs. However, each video input can be set to display its own audio meters as desired. • When Audio Meter Overlays are enabled for multiple inputs, each meter grouping can be individually positioned, sized, and set up as described here. 	
<p>• PIP Configure Select</p> 	<p>Individually selects embedded audio from any of the five video inputs to be selected as source for Audio Meter insertion setup (as described below).</p>
<p>• Meter Insertion Enable/Disable</p> 	<p>Enables or disables Audio Meter insertion for selected input source.</p>
<p>• Layout Select</p> 	<p>Selects from several preset layout templates and custom from the choices shown and depicted below.</p> <p>Note: Stereo selections are always correlated to embedded channels 1 and 2.</p>

Table 3-1 9978-ANC-MON Function Menu List — continued

Example Meter Layouts

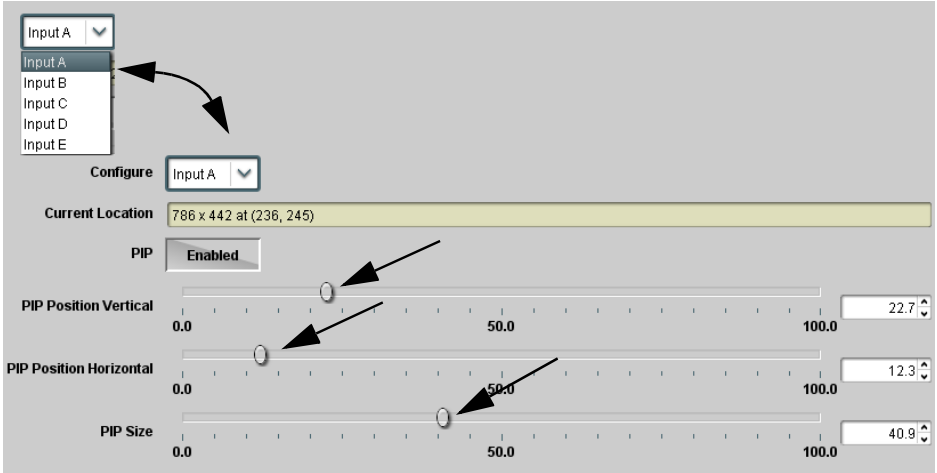
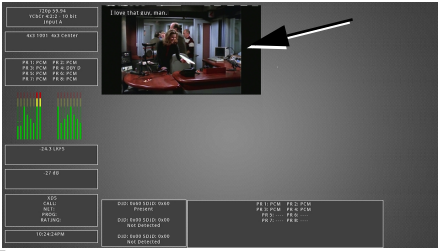
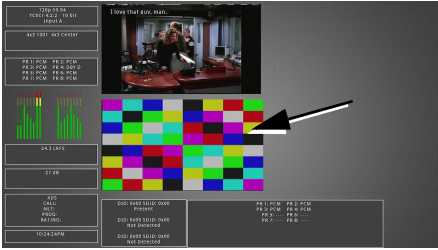
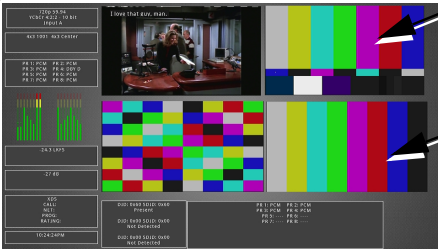
Stereo snap left

Stereo snap right

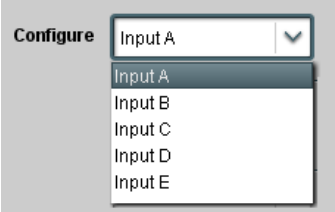
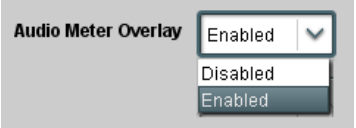
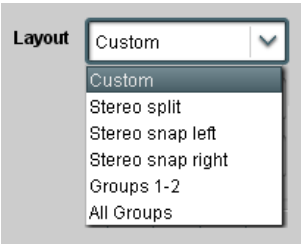
Stereo split

Groups 1-2

All Groups

Custom

• **Number of Meters / Split Between Meters / Position (Custom Mode only)**

Number of Meters 1

1

2

•

•

•

•

16

Split Between Meters No Split

No Split

1 and 2

•

•

•

•

15 and 16

Split Width

0.0

Vertical Position

0.0

Horizontal Position

0.0

Where **Custom** mode is selected, allows for custom number of meter channels displayed, as well as a split between meters (if desired) which can be set between any pair.

Split Width controls sets the space between the space between the division set using the **Split Between Meters** control.

Split Width set at minimum (no split)

Split Width set at maximum (split pushes 2nd pair flush right)

Position controls raise the meter base when the control setting is increased, and move the display as a unit left or right.

Note: Where custom channel number complement is configured, channel correlation is always contiguous assignments starting at embedded channel 1.

3-16

9978-ANC-MON PRODUCT MANUAL

9978-ANC-MON-OM (V1.1)

Table 3-1 9978-ANC-MON Function Menu List — continued









	(continued)
<p>• Meter Width Control</p> 	<p>Sets the relative height of the audio bars.</p> 
<p>• Meter Height Control</p> 	<p>Sets the relative height of the audio bars.</p> 
<p>• Meter Opacity Control</p> 	<p>Sets the relative opacity of the audio bars.</p> 
<p>• Meter Brightness Control</p> 	<p>Sets the relative brightness of the Audio Meter insertion.</p>

Table 3-1 9978-ANC-MON Function Menu List — continued

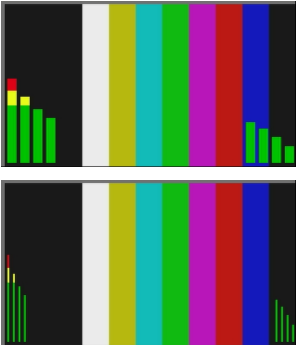
<div style="background-color: #333; color: white; padding: 5px; text-align: center; font-weight: bold;">Audio Meter Overlay</div>	(continued)
<p>• Meter Borders Select</p> <div style="border: 1px solid #ccc; padding: 5px; margin-top: 10px;"> <p>Meter Border ▼</p> <div style="border: 1px solid #ccc; padding: 2px; margin-top: 2px;"> Disabled </div> <div style="border: 1px solid #ccc; padding: 2px; margin-top: 2px;"> Disabled </div> <div style="border: 1px solid #ccc; padding: 2px; margin-top: 2px;"> Enabled </div> </div>	

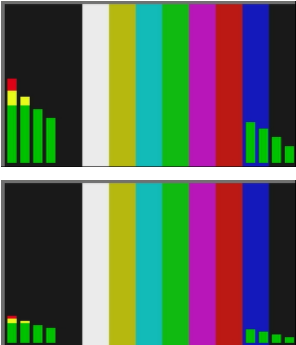
Table 3-1 9978-ANC-MON Function Menu List — continued

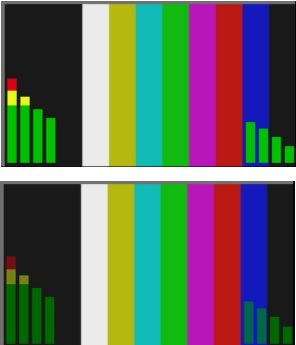
<p>Output Audio</p>	<p>Provides an audio crosspoint allowing the audio source selection for each embedded audio output channel. Also provides Gain, Phase Invert, and Muting controls and peak level meters for each output channel.</p>
<p>Note:</p> <ul style="list-style-type: none"> • Embedded Ch 2 thru Embedded Ch 16 have controls identical to the Source, Gain, Mute, and Invert controls described here for Embedded Ch 1. Therefore, only the Embedded Ch 1 controls are shown here. • For each channel, its source and destination should be considered and appropriately set. Unused destination channels should be set to the Silence selection. 	
<p>• Embedded Audio Output Input Source</p> 	<p>Selects the four-group embedded audio to be embedded in the output embedded SDI audio (and HDMI Ch1 - Ch8 embedded audio). (In this example, Input A audio is selected as the output four-group audio.)</p>
<p>• Group Enable/Disable Controls</p> 	<p>Allows enable/disable of embedded audio groups 1 thru 4 on card program video output to accommodate some legacy downstream systems that may not support all four embedded audio groups.</p> <p>Note: Changing the setting of this control will result in a noise burst in all groups. This control should not be manipulated when carrying on-air content.</p>
<p>• Embedded Output Channel Source</p> 	<p>Using the drop-down list, selects the audio input source to be embedded in the corresponding embedded output channel from embedded Ch 1 thru Ch 16 choices.</p>
<p>• Channel Mute/Phase Invert/Gain Controls and Peak Level Display</p> 	<p>Provides Mute and phase Invert channel controls, as well as peak level meter for each output channel. (Meter shows level as affected by Level control.)</p> <p>Gain controls allow relative gain (in dB) control for the corresponding destination Embedded Audio Group channel.</p> <p>(-80 to +20 dB range in 1.0 dB steps; unity = 0 dB)</p> <p>Note: Although this card can pass non-PCM data such as Dolby® E or AC-3, setting the gain control to any setting other than default 0 will corrupt Dolby data.</p>

Table 3-1 9978-ANC-MON Function Menu List — continued

<p>Audio Monitoring Setup</p> <p>Dolby Metadata LKFS</p>	<p>Provides Dolby metadata display for Dolby input audio. Also provides LKFS setup and measurement displays for PCM input audio.</p>
<p>Dolby Metadata subtab shows Dolby status for embedded pair carrying Dolby content.</p> <p>For selected SDI input (Input A in this example) and selected embedded pair (pair Ch 7/8 in this example), Dolby status is shown as in the example here.</p> <p>If selected pair is not carrying Dolby, blanks are shown for all fields.</p>	
<p>LKFS subtab allows LKFS channel line-up setup and averaging window setup for PCM payload. Using the settings performed here, this is the data that is shown when LKFS is selected as a status field in Status Field Layout Controls (p. 3-10).</p> <p>Note: LKFS is available only for SDI Input A.</p>	

Table 3-1 9978-ANC-MON Function Menu List — continued

<p style="text-align: center;">SCTE 104</p>	<p>Provides controls and status displays for displaying SCTE 104 messages including detailed history and metrics. Setup performed here is propagated to Status Field(s) set to display SCTE 104 as a SCTE message summary.</p>
<p>• SCTE 104 Log Setup</p> <p>Ignore... check boxes allow periodic heartbeat messages to be suppressed from the log.</p> <p>Download Log File allows log file opens browser to allow download file save.</p> <p>Enable SCTE 104 Logging serves as master control to enable logging. This must be checked to generate log files.</p> <p>Note: Although the history display shows last three most recent messages, log file records all activity until cleared.</p>	<p>Provides controls for setting up, saving, and clearing SCTE 104 message activity logging.</p>  <p>Clear SCTE 104 Log clears any logged data and sets up empty log for new logging file.</p>
<p>• SCTE 104 Message History Display</p>	<p>Provides a summary of last three messages received. Also provides an expandable tree view which provides detail status and metrics for each displayed time-stamped activity.</p>
<p>Last three most recent messages are displayed. (The summary shown here is propagated to Status Field display set for SCTE 104 Status (see SCTE 104 Display (p. 3-11) for details.)</p> <p>Where Mult Operation Msg (Multi-Operation Message) appears, this indicates an expansion tree can be opened, showing more details and metrics related to the activity. Click the arrow to expand or collapse the tree view (as shown in example below). Where text is available, this can also be accessed using this view.</p> 	

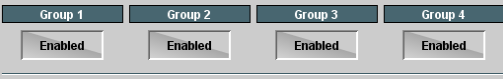
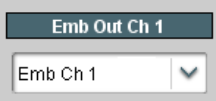
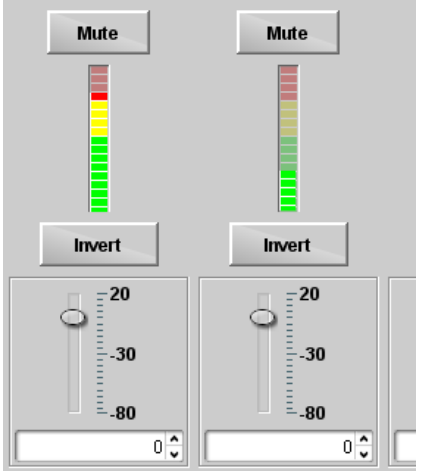
Table 3-1 9978-ANC-MON Function Menu List — continued

User DID/SDID Monitoring	Provides controls and status displays for setting up DID/SDID monitoring. Setup performed here is propagated to Status Field(s) set to display User DID/SDID monitoring.
<p>User DID/SDID Monitoring allows user definition of up to three DID/SDID monitoring locations.</p> <p>Note:</p> <ul style="list-style-type: none"> • DashBoard 4.1 and earlier has DID/SDID settings entered as decimal values. Newer DashBoard versions use hexadecimal entries. • DID/SDID locations are set here. However, the SDI stream queried is set using the Source Select drop-down on the Status Field (1 thru 15) controls (see Status Field Layout Controls (p. 3-10)). Multiple SDI streams can be checked for user DID/SDID using multiple Status Fields set for the desired SDI stream complement. 	 <p>The screenshot displays a configuration panel for 'User DID/SDID Monitoring'. It is organized into three sections: 'User Data 1', 'User Data 2', and 'User Data 3'. Each section contains three fields: 'DID', 'SDID', and 'Status'. - User Data 1: DID is set to 0x60, SDID is set to 0x60, and the Status is 'Present' (indicated by a green circle). - User Data 2: DID is set to 0x0, SDID is set to 0x0, and the Status is 'Not Detected' (indicated by a yellow circle). - User Data 3: DID is set to 0x0, SDID is set to 0x0, and the Status is 'Not Detected' (indicated by a yellow circle).</p>

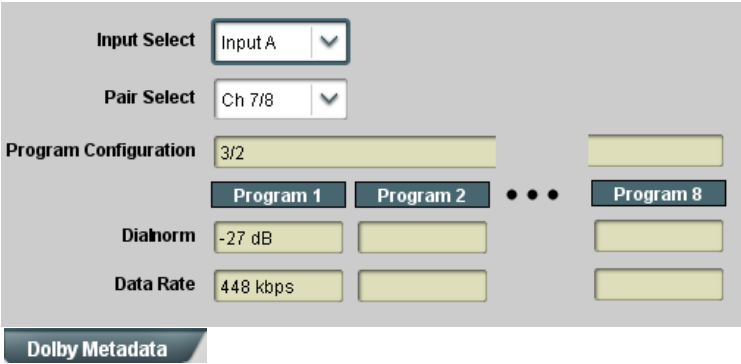
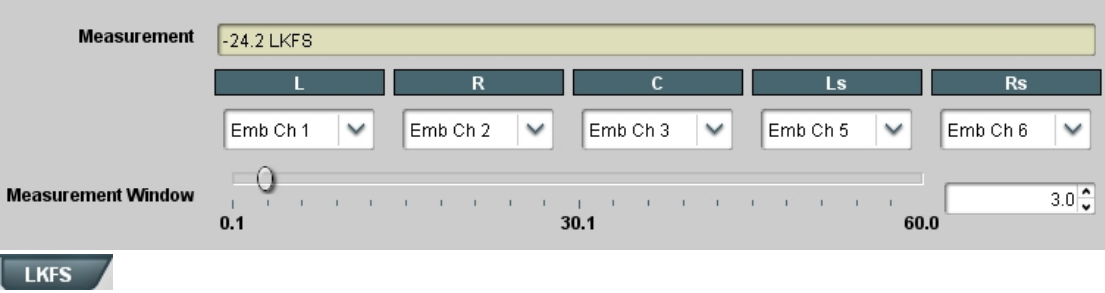
Table 3-1 9978-ANC-MON Function Menu List — continued

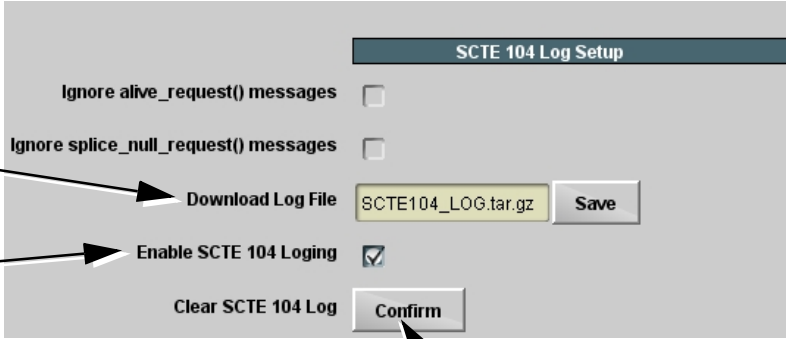
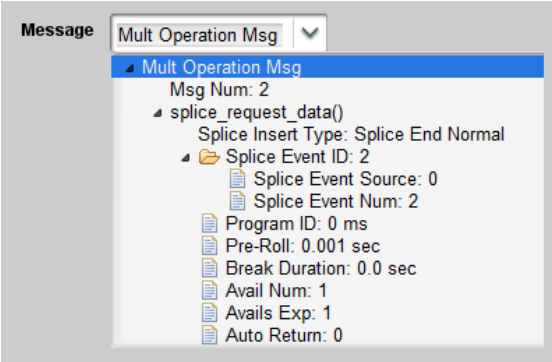
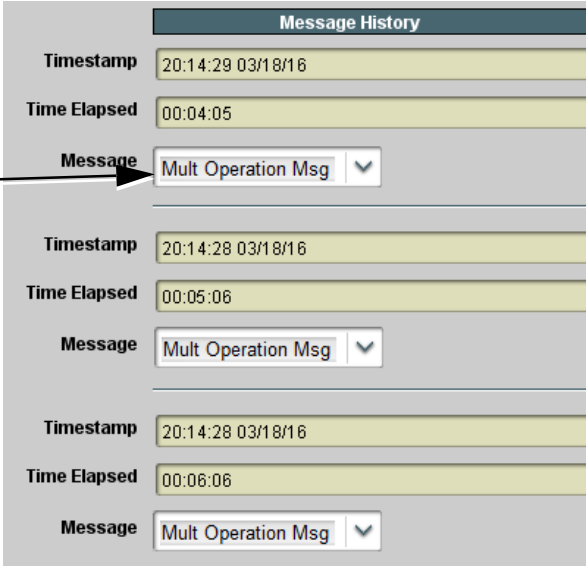

	<p>Provides controls to set merged multiviewer/status output raster for SDI and HDMI outputs.</p> <p>Also provides settings to force an HDMI or DVI output suitable for direct connection to monitors using a DVI input in case the connection is not detected by the monitor. Also provides color mode controls to match HDMI/DVI output to the color space of the monitor.</p>
<p>• Output Format Selector</p> 	<p>Provides conversions to formats as shown.</p> <p>Note:</p> <ul style="list-style-type: none"> • Although drop-down and card will allow output video raster/rate choices unrelated to the input rates (for example, PAL 50Hz rate for NTSC 59.94Hz input rates), cross-rate conversion choices should not be used for critical applications (frames will be dropped when performing such conversions). • Background fill of this device is optimized for 1080 formats, therefore all output format choices are limited to 1080 choices.
<p>• Underscan Select</p> 	<p>Provides underscanning to reduce the merged output raster size by choices shown.</p>
<p>• Video Lock Mode Select</p> 	<p>Selects lock to reference functions from the choices shown and described below.</p> <ul style="list-style-type: none"> • Free Run: PiP inputs and output video is locked to the card's internal clock. Output video is not locked to external reference. • Lock to Reference: PiP inputs and output video is locked to selected external reference (Ref 1 or Ref 2) received on the frame reference bus, else input. • Lock to Input A: Uses Input A program video input video signal as the reference standard, else free-run. <p>Note: Lock to reference provides the most stable operation, and is preferred where available. In this case, source video should also be locked to the same reference.</p>
<p>• Frame Delay Control</p> 	<p>When Framesync is enabled, specifies the smallest amount of latency delay (frames held in buffer) allowed by the frame sync. The frame sync will not output a frame unless the specified number of frames are captured in the buffer.</p>
<p>• HDMI Mode Control</p> 	<p>Sets HDMI/DVI output to use the connected monitor to inform 9978-ANC-MON to automatically detect the monitor format, or to use manual (forced) control.</p> <p>Where the monitor may not be able to provide this handshake signal, it is recommended to use Manual mode and force the desired mode as described below.</p>

Table 3-1 9978-ANC-MON Function Menu List — continued

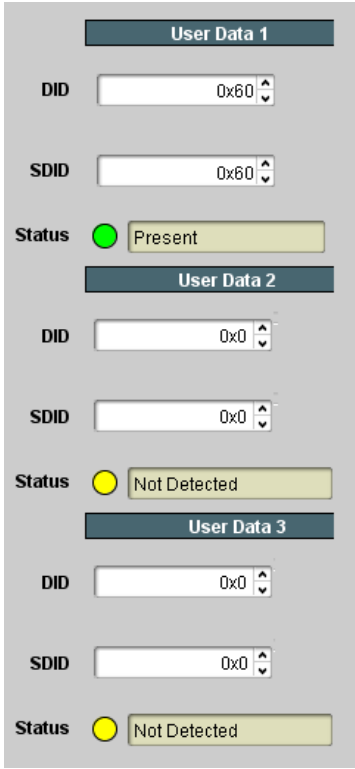

Output Format	(continued)																					
<p>• HDMI/DVI Format Manual (Forced) Mode Control</p> 	<p>When set to Manual Control, sets HDMI output as forced HDMI or DVI mode.</p>																					
<p>• HDMI Colorspace Control</p> 	<p>Forces output colorspace as either YCbCr or RGB.</p>																					
<p>Note: The HDMI output on this card conforms with CEA-861D HDMI audio channel line-up specifications. As such, a swap between the C and LFE channels for the HDMI output is automatically performed.</p> <p>If connecting to a device that does not meet CEA-861D HDMI, a Ch3 / Ch4 swap using the Output Audio Routing/Controls may be required to effect desired C - LFE line-up.</p> <div style="text-align: center;"> <table border="0"> <thead> <tr> <th style="text-align: left;">SDI SMPTE Convention</th> <th style="text-align: center;">9978-ANC-MON Conversion</th> <th style="text-align: right;">Automatic Re-Line-up to CEA-861 Convention</th> </tr> </thead> <tbody> <tr> <td>L</td> <td>—</td> <td>L</td> </tr> <tr> <td>R</td> <td>—</td> <td>R</td> </tr> <tr> <td>C</td> <td>—</td> <td>LFE</td> </tr> <tr> <td>LFE</td> <td>—</td> <td>C</td> </tr> <tr> <td>Ls</td> <td>—</td> <td>Ls</td> </tr> <tr> <td>Rs</td> <td>—</td> <td>Rs</td> </tr> </tbody> </table> </div>		SDI SMPTE Convention	9978-ANC-MON Conversion	Automatic Re-Line-up to CEA-861 Convention	L	—	L	R	—	R	C	—	LFE	LFE	—	C	Ls	—	Ls	Rs	—	Rs
SDI SMPTE Convention	9978-ANC-MON Conversion	Automatic Re-Line-up to CEA-861 Convention																				
L	—	L																				
R	—	R																				
C	—	LFE																				
LFE	—	C																				
Ls	—	Ls																				
Rs	—	Rs																				

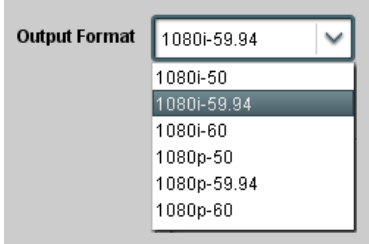
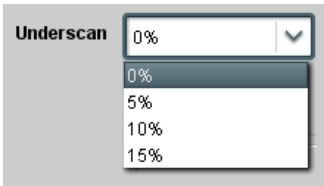
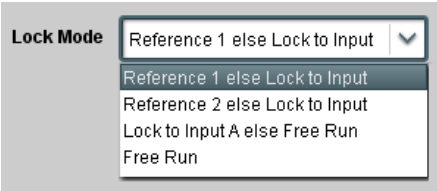
Table 3-1 9978-ANC-MON Function Menu List — continued

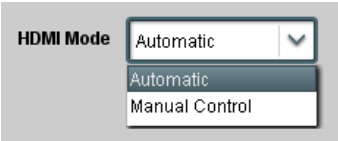

	<p>Provides controls for setting and inserting wall-clock time into merged output or as a per-PiP insertion selection.</p>
<p>• Clock Mode / Set Controls</p> 	<p>Allows clock time and display mode to be set as follows:</p> <ul style="list-style-type: none"> • Clock Mode selects between 24-hour (“military”) time, or time using AM and PM designations. • Clock Source selects user-entered arbitrary time or NTP-synced time. • Local Timezone provides timezone offsets for localization when using NTP time. • Card Time display shows the currently configured running wall-clock time (whether set as user-entered arbitrary time or NTP-synced time). <p>Note: NTP syncing is only done at various intervals. To invoke resyncing, power-cycle to card to immediately sync with NTP.</p>
<p>• User Set Mode Controls</p> 	<p>When Clock Source is set to User Set Time, allows entry of user time, and also allows entry of user text identifying the time zone or other text (this time zone text is displayed when entered for either user time or NTP time)</p> <p>Click Set Time to invoke user set time.</p>
<p>Note: Clock can be burned in as an overlay over the merged split output (using the controls below) and/or as a per-PiP insertion using the individual PiP 1 thru PiP 5 UMD/Idents insertion controls. Where insertion as a per-PiP Ident burn-in is desired, the enable control below does not have to be set to Enabled.</p>	
<p>• Clock Overlay Select/Enable</p> 	<ul style="list-style-type: none"> • Clock Overlay allows wall-clock time to be burned into the overall merged video output. Also allows selecting source as NTP/User or external LTC. • Global LTC Source selects from RS232 or RS422 external timecode source when LTC is selected above. • Display Format (when LTC is selected above) selects the format of timecode string burn-in overlay insertion from choices shown. <p>Clock Overlay set to Enabled inserts a clock burn-in into the merged video output and not directly bound to any PiP area</p> 

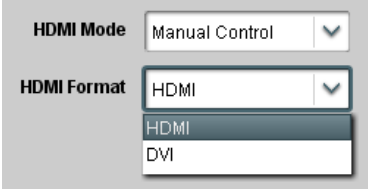
Table 3-1 9978-ANC-MON Function Menu List — continued

	(continued)
<ul style="list-style-type: none"> • Clock Character Size and Custom Position Controls 	<p>Horizontal and Vertical Position controls set the origin point for the clock overlay.</p> 
<ul style="list-style-type: none"> • Clock Text Character/Background Attributes Controls 	<p>Provides independent controls for setting the color and opacity of the clock text and its background.</p> <ul style="list-style-type: none"> • Color drop-downs set text or background color from multiple choices. • Opacity controls set text or background opacity from 0% (least opacity) to 100% (full opacity).

Table 3-1 9978-ANC-MON Function Menu List — continued

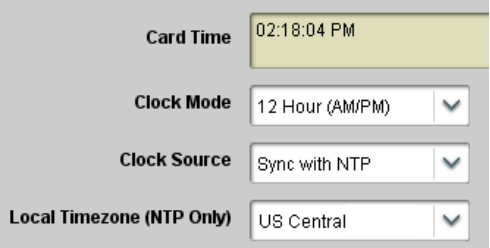
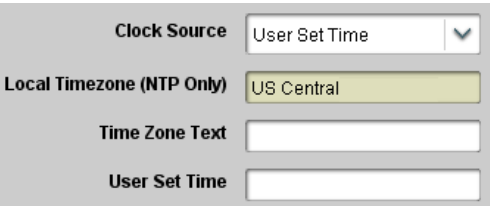
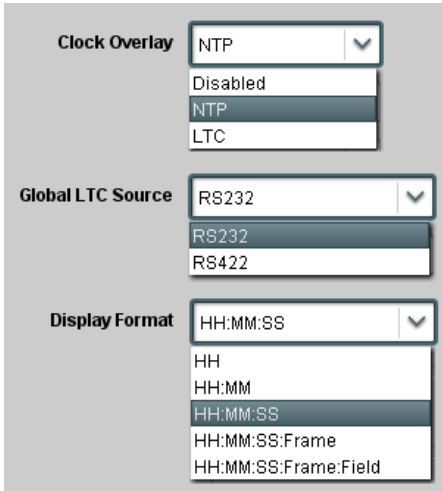

	<p>Allows user control settings to be saved in a one-button Preset and then loaded (recalled) as desired, and provides a one-button restore of factory default settings.</p>
<p>• Preset Layer Select</p> <p>Allows selecting a functional layer (or “area of concern”) that the preset is concerned with. Limiting presets to a layer or area of concern allows for highly specific presets, and masks changing card settings in areas outside of the layer or area of concern.</p> 	<p>Default All setting will “look” at all device settings, and save and invoke all settings when the preset is invoked (loaded).</p> <p>Selecting a layer (in this example, “Closed Caption”) will set the preset to only “look at” and “touch” closed captioning settings and save these settings under the preset. When the preset is invoked (loaded), only the closed caption layer is “touched”. Invoking a layered preset will not change any settings that are in effect that are outside of the layer of concern.</p>
<p>• Preset Enter/Save/Delete</p>  <p>Protected state – changes locked out</p> <p>Ready (open) state – changes can be applied</p>	<p>Locks and unlocks editing of presets to prevent accidental overwrite as follows:</p> <ul style="list-style-type: none"> Protect (ready): This state awaits Protected and allows preset Save/Delete button to save or delete current card settings to the selected preset. Use this setting when writing or editing a preset. Protected: Toggle to this setting to lock down all presets from being inadvertently re-saved or deleted. Use this setting when all presets are as intended. Create New Preset: Field for entering user-defined name for the preset being saved (in this example, “IRD Rcv122”). Save: Saves the current card settings under the preset name defined above.
<p>• Preset Save/Load Controls</p> 	<ul style="list-style-type: none"> Select Preset: drop-down allows a preset saved above to be selected to be loaded or deleted (in this example, custom preset “IRD Rcv122”). Load Selected Preset button allows loading (recalling) the selected preset. When this button is pressed, the changes called out in the preset are immediately applied. Update Selected Preset button allows saving any card settings changes to the selected preset. When this button is pressed, the changes in effect are rolled into the selected preset. Delete Selected Preset button deletes the currently selected preset. Load Factory Defaults button allows loading (recalling) the factory default preset. When this button is pressed, the changes called out in the preset are immediately applied. <p>Note: Load Factory Defaults functions with no masking. The Preset Layer Select controls have no effect on this control and will reset all layers to factory default.</p> <ul style="list-style-type: none"> Download Presets saving the preset files to a folder on the connected computer.

Table 3-1 9978-ANC-MON Function Menu List — continued

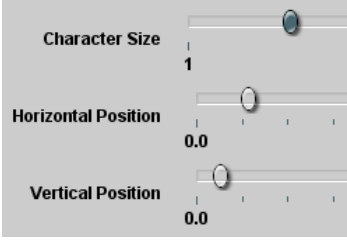
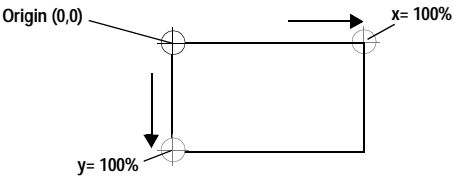
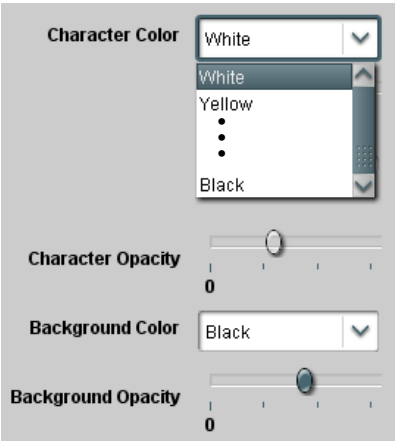

Presets	(continued)
<p>Download (save) card presets to a network computer by clicking Download Presets – Save at the bottom of the Presets page.</p>	<p>Upload (open) card presets from a network computer by clicking Upload at the bottom of DashBoard.</p>
	
<p>Browse to a desired save location (in this example, <i>My Documents\Cobalt Presets</i>). The file can then be renamed if desired (<i>RCVR21 Presets</i> in this example) before committing the save.</p>	<p>Browse to the location where the file was saved on the computer or drive (in this example, <i>My Documents\Cobalt Presets</i>).</p>
	
	<p>Select the desired file and click Open to load the file to the card.</p>
	<p>Note:</p> <ul style="list-style-type: none"> • Preset transfer between card download and file upload is on a group basis (i.e., individual presets cannot be downloaded or uploaded separately). • After uploading a presets file, engagement of a desired preset is only assured by selecting and loading a desired preset as described on the previous page.

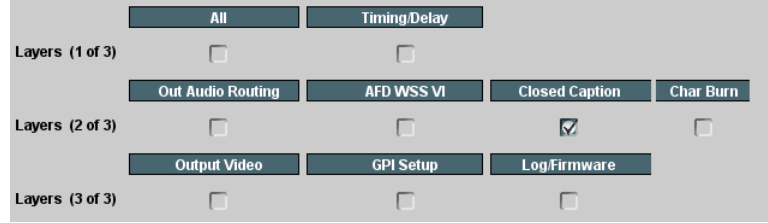
Table 3-1 9978-ANC-MON Function Menu List — continued

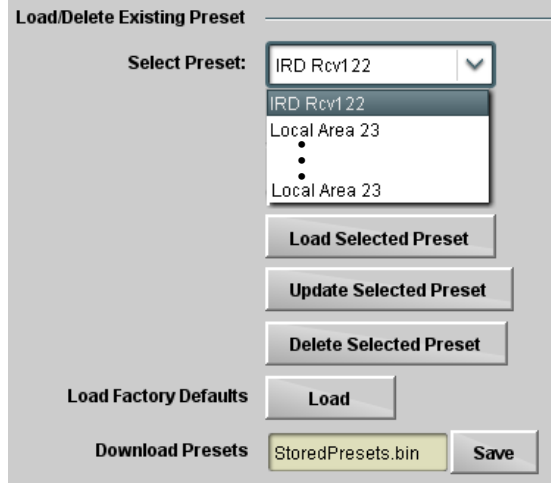

	<p>Provides a global card operating status and allows a log download for factory engineering support. Also provides controls for selecting and loading card firmware upgrade files.</p> <p>Networking controls provide dedicated card networking setup in conjunction with rear module Ethernet port.</p>
<p>• Log Status and Download Controls</p> 	<ul style="list-style-type: none"> • Log Status indicates overall card internal operating status. • Download Log File allows a card operational log file to be saved to a host computer. This log file can be useful in case of a card error or in the case of an operational error or condition. The file can be submitted to Cobalt engineering for further analysis. • Thermal Shutdown enable/disable allows the built-in thermal failover to be defeated. (Thermal shutdown is enabled by default). <p>CAUTION</p> <p>The 9978-ANC-MON FPGA is designed for a normal-range operating temperature around 85° C core temperature. Operation in severe conditions exceeding this limit for non-sustained usage are within device operating safe parameters, and can be allowed by setting this control to Disable. However, the disable (override) setting should be avoided under normal conditions to ensure maximum card protection.</p>
<p>• Card DashBoard Name Control</p> 	<p>Allows card name In DashBoard to be changed as desired. Click return to engage change.</p> <ul style="list-style-type: none"> • Append to Product Name appends (or adds to) existing OEM name (for example, "9978-ANC-MON Processing 1A"). • Replace Product Name completely replaces the OEM name OEM name (for example, "Processing 1A"). <p>Note: DashBoard instance(s) may have to be refreshed before name change appears.</p>

Table 3-1 9978-ANC-MON Function Menu List — continued

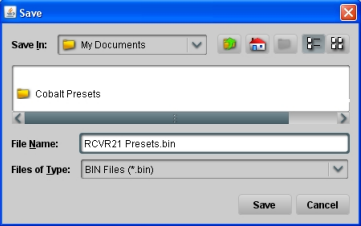
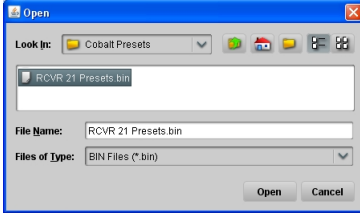
<div style="background-color: #333; color: white; padding: 5px; text-align: center; font-weight: bold; font-size: 1.2em;">Admin</div> <hr/> <div style="display: flex; justify-content: space-around; background-color: #eee; padding: 2px;"> System Networking </div>	<p>(continued)</p>
<ul style="list-style-type: none"> • Firmware Upgrade Controls 	<p>Firmware upgrade controls allow a selected firmware version (where multiple versions can be uploaded to the card's internal memory) to invoke an upgrade to a selected version either instantly, or set to install on the next card reboot (thereby allowing card upgrade downtime to be controlled at a scheduled point in time).</p>
<p>Note: The page/tab here allows managing multiple firmware versions saved on the card. New upgrade firmware from our web site can always be directly uploaded to the card without using this page. Instructions for firmware downloading to your computer and uploading to the card can be found at the Support>Firmware Downloads link at www.cobaltdigital.com.</p>	
<ol style="list-style-type: none"> 1. Access a firmware upgrade file from a network computer by clicking Upload at the bottom of Dashboard. 2. Browse to the location of the firmware upgrade file (in this example, <i>My Documents\lv1.0.0019.bin</i>). 3. Select the desired file and click Open to upload the file to the card. 	 
<ul style="list-style-type: none"> • Immediate firmware upload. The card default setting of Automatically Reboot After Upgrade checked allow a selected firmware version to be immediately uploaded as follows: <ol style="list-style-type: none"> 1. Click Firmware To Load and select the desired upgrade file to be loaded (in this example, "v1.0.0019"). 2. Click Load Selected Firmware. The card now reboots and the selected firmware is loaded. 	
<ul style="list-style-type: none"> • Deferred firmware upload. With Automatically Reboot After Upgrade unchecked, firmware upgrade loading is held off until the card is manually rebooted. This allows scheduling a firmware upgrade downtime event until when it is convenient to experience to downtime (uploads typically take about 60 seconds). <ol style="list-style-type: none"> 1. Click Firmware To Load and select the desired upgrade file to be loaded (in this example, "v1.0.0019"). Note now how the display shows "Installs on Next Reboot". 2. Click Load Selected Firmware. The card holds directions to proceed with the upload, and performs the upload only when the card is manually rebooted (by pressing the Reboot button). 3. To cancel a deferred upload, press Cancel Pending Upgrade. The card reverts to the default settings that allow an immediate upload/upgrade. 	

Table 3-1 9978-ANC-MON Function Menu List — continued

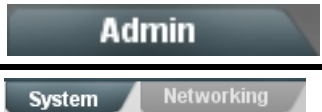

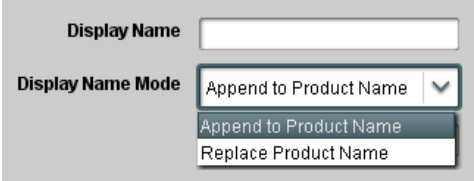



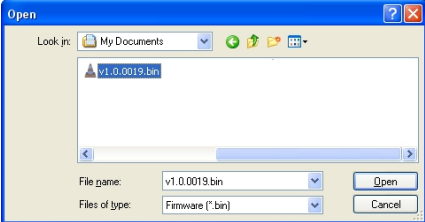
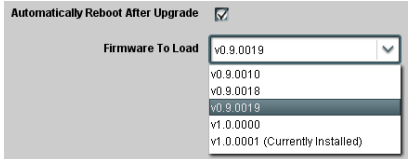
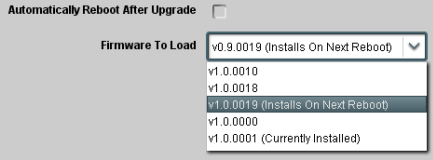

	<p>(continued)</p>
<p>• Card Check and Restore Utilities</p>  <p>Memory Test Status Running Memory Test: 8.99%</p> <p>Memory Test Status Memory test completed successfully, please reboot the card</p> 	<p>Memory Test allows all cells of the card FPGA memory to be tested.</p>  <p>This control should only be activated under direction of product support. Exercising the memory test is not part of normal card maintenance.</p> <p>Restore from SD Card allows card rendered inoperable to be restored using an SD memory card fitted to the card internal SD slot.</p>  <p>Product support must be contacted prior to performing this operation. Use of any SD card not supplied by support can corrupt the card.</p>
	<p>The Networking sub-tab provides a dedicated Ethernet connection to card control and monitoring via a rear module Ethernet port. (This IP interface is entirely independent and separate from the card's DashBoard frame-based remote control/monitoring interface.)</p> <p>(Dedicated card control using IP has not been fully implemented at this release. Some functions may be reserved.)</p>
<p>• Card IP Physical Port Select Control</p> 	<p>Allows card dedicated IP interface (as set below) to use frame communications or dedicated rear I/O module Ethernet RJ-45 port.</p> <p>Note:</p> <ul style="list-style-type: none"> • Frame net connection allows cards with per-card Ethernet connection to connect with network via a shared frame Ethernet port instead of per-card dedicated Ethernet connectors on the card's rear module. Frame net connection is available only on certain frame models. • Card slot must be fitted with a rear I/O module equipped with an Ethernet connector in order to use Rear I/O selection.
<p>• Card IP Setup Controls</p> 	<p>Provides controls for setting up card dedicated IP interface.</p> <ul style="list-style-type: none"> • Addressing Mode selects either DHCP or static. <p>Where Static is selected, standard IP fields allow entry of Address, Subnet Mask, and Default Gateway.</p>
<p>• Card SNMP MIB Download</p> 	<p>Where supported, allows card SNMP MIB files to be downloaded and saved using user-configured name.</p>

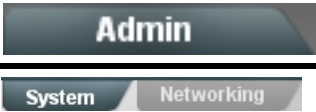
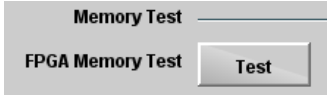
Table 3-1 9978-ANC-MON Function Menu List — continued

  	(continued)															
<p>• NTP Clock Setup</p> <p>Clock Setup</p> <p>NTP IP (use 0.0.0.0 for pool NTP) <input type="text" value="0.0.0.0"/></p> <p>Local Timezone (NTP Only) <input type="text" value="US-Central"/></p> <p>NTP Status <input type="text" value="Synchronized with NTP"/></p> <p>Use Network Interface for NTP <input checked="" type="checkbox"/></p> <p>Use Frame Network Card for NTP <input type="checkbox"/></p>	<p>Allows device NTP clock IP source and localization. This is the clock/time device will use for logs and other recorded actions.</p> <ul style="list-style-type: none"> • NTP IP sets the IP address where NTP is to be obtained. • Local Timezone sets the recorded time to the localized time. • NTP Status shows if time is synced with NTP or if an error exists. • Use Network Interface and User Frame Network Card checkboxes allows selecting the network source that will provide NTP time. 															
	<p>Automatically maintains a log of user actions and input lock status.</p>															
<p>User Log shows input lock and other user conditions (with most recent event at top of list).</p> <p>Clear User Log clears all entries.</p> <p>Download Log File opens a browser allowing the log file to be saved on the host machine.</p>	 <table border="1"> <thead> <tr> <th>Time</th> <th>Type</th> <th>Event</th> </tr> </thead> <tbody> <tr> <td>22:40:36 12/02/15</td> <td>Info</td> <td>SDI Input sdi_in_c Locked to 720p 59.94</td> </tr> <tr> <td>22:40:34 12/02/15</td> <td>Info</td> <td>SDI Input sdi_in_d Locked to 1080i 59.94</td> </tr> <tr> <td>21:17:36 12/02/15</td> <td>Info</td> <td>SDI Input sdi_in_b Locked to 1080i 59.94</td> </tr> <tr> <td>21:17:18 12/02/15</td> <td>Info</td> <td>Log file cleared</td> </tr> </tbody> </table> <p>Clear User Log <input type="button" value="Confirm"/></p> <p>Download Log File <input type="text" value="9922-F8.tar.gz"/> <input type="button" value="Save"/></p>	Time	Type	Event	22:40:36 12/02/15	Info	SDI Input sdi_in_c Locked to 720p 59.94	22:40:34 12/02/15	Info	SDI Input sdi_in_d Locked to 1080i 59.94	21:17:36 12/02/15	Info	SDI Input sdi_in_b Locked to 1080i 59.94	21:17:18 12/02/15	Info	Log file cleared
Time	Type	Event														
22:40:36 12/02/15	Info	SDI Input sdi_in_c Locked to 720p 59.94														
22:40:34 12/02/15	Info	SDI Input sdi_in_d Locked to 1080i 59.94														
21:17:36 12/02/15	Info	SDI Input sdi_in_b Locked to 1080i 59.94														
21:17:18 12/02/15	Info	Log file cleared														

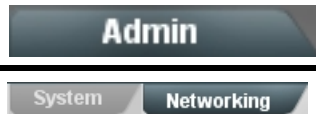
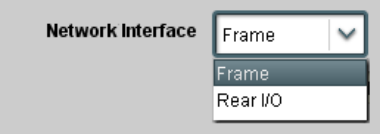
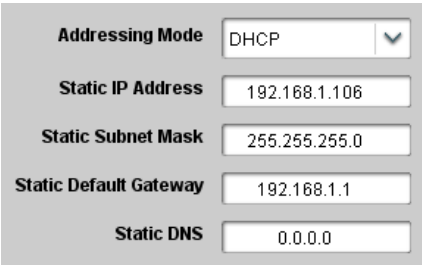
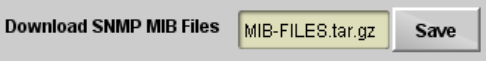
Troubleshooting

This section provides general troubleshooting information and specific symptom/corrective action for the 9978-ANC-MON card and its remote control interface. The 9978-ANC-MON card requires no periodic maintenance in its normal operation; if any error indication (as described in this section) occurs, use this section to correct the condition.

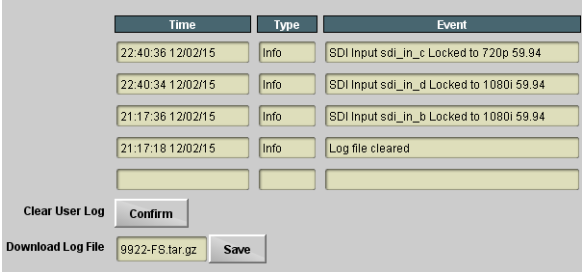
Error and Failure Indicator Overview

The 9978-ANC-MON card itself and its remote control systems all (to varying degrees) provide error and failure indications.

The various 9978-ANC-MON card and remote control error and failure indicators are individually described below.

Note: The descriptions below provide general information for the various status and error indicators. For specific failures, also use the appropriate subsection listed below.

- Basic Troubleshooting Checks (p. 3-36)
- 9978-ANC-MON Processing Error Troubleshooting (p. 3-37)
- Troubleshooting Network/Remote Control Errors (p. 3-38)

9978-ANC-MON Card Edge Status/Error Indicators and Display

Figure 3-5 shows and describes the 9978-ANC-MON card edge status indicators and display. These indicators and the display show status and error conditions relating to the card itself and remote (network) communications (where applicable). Because these indicators are part of the card itself and require no external interface, the indicators are particularly useful in the event of communications problems with external devices such as network remote control devices.

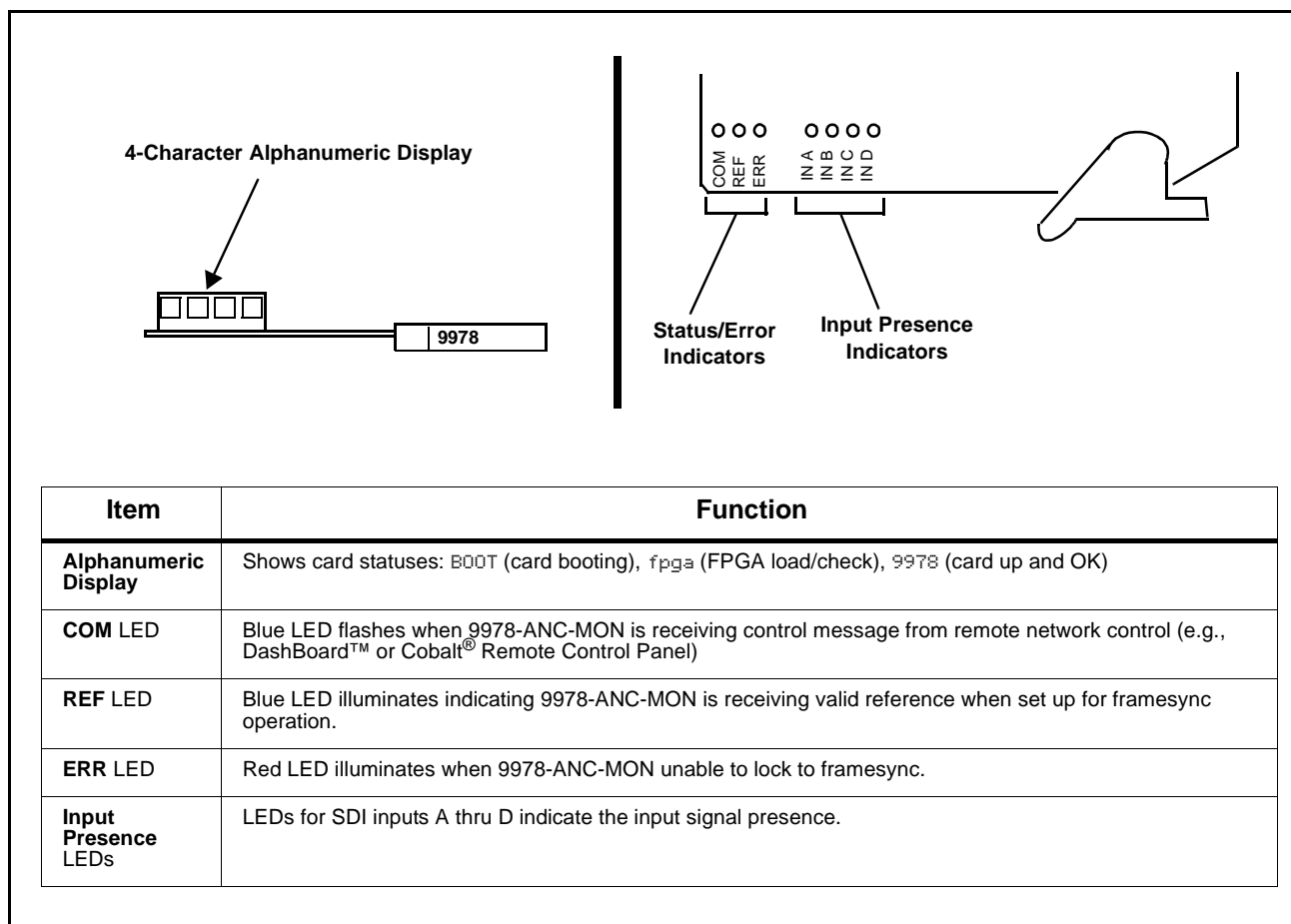

Figure 3-5 9978-ANC-MON Card Edge Status Indicators and Display

DashBoard™ Status/Error Indicators and Displays

Figure 3-6 shows and describes the DashBoard™ status indicators and displays. These indicator icons and displays show status and error conditions relating to the 9978-ANC-MON card itself and remote (network) communications.

Indicator Icon or Display	Error Description
	<p>Red indicator icon in Card Access/Navigation Tree pane shows card with Error condition (in this example, the Card Access/Navigation Tree pane shows a general error issued by the 9978-ANC-MON card in slot 6).</p> <p>Specific errors are displayed in the Card Info pane (in this example “No connection to device” indicating 9978-ANC-MON card is not connecting to frame/LAN).</p> <p>If the 9978-ANC-MON card is not connecting to the frame or LAN, all controls are grayed-out (as shown in the example here).</p>
	<p>Gray indicator icon in Card Access/Navigation Tree pane shows card(s) are not being seen by DashBoard™ due to lack of connection to frame LAN (in this example, both a 9978-ANC-MON card in slot 6 and the MFC-8320-N Network Controller Card for its frame in slot 0 are not being seen).</p>
	<p>Yellow indicator icon in Card Access/Navigation Tree pane shows card with Alert condition (in this example, the Card Access/Navigation Tree pane shows a general alert issued by the MFC-8320-N Network Controller Card).</p> <p>Clicking the card slot position in the Card Access/Navigation Tree (in this example Network Controller Card “Slot 0: MFC-8320-N”) opens the Card Info pane for the selected card. In this example, a “Fan Door Open” specific error is displayed.</p>
	<p>Yellow indicator icon in 9978-ANC-MON Card Info pane shows error alert, along with cause for alert (in this example, the 9978-ANC-MON is not receiving an enabled framesync source).</p>

Figure 3-6 DashBoard™ Status Indicator Icons and Displays

Access Card Info panes for specific cards by clicking the card slot position in the Card Access/Navigation Tree pane (as shown in the example in Figure 3-7).

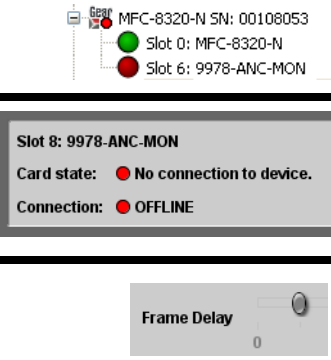
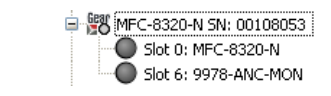
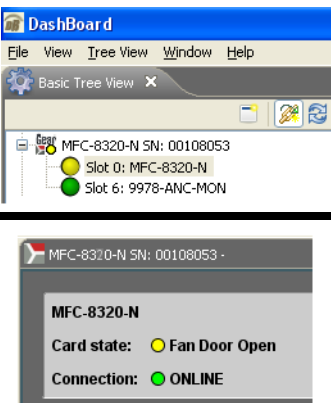
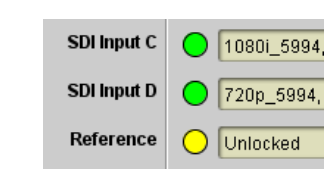
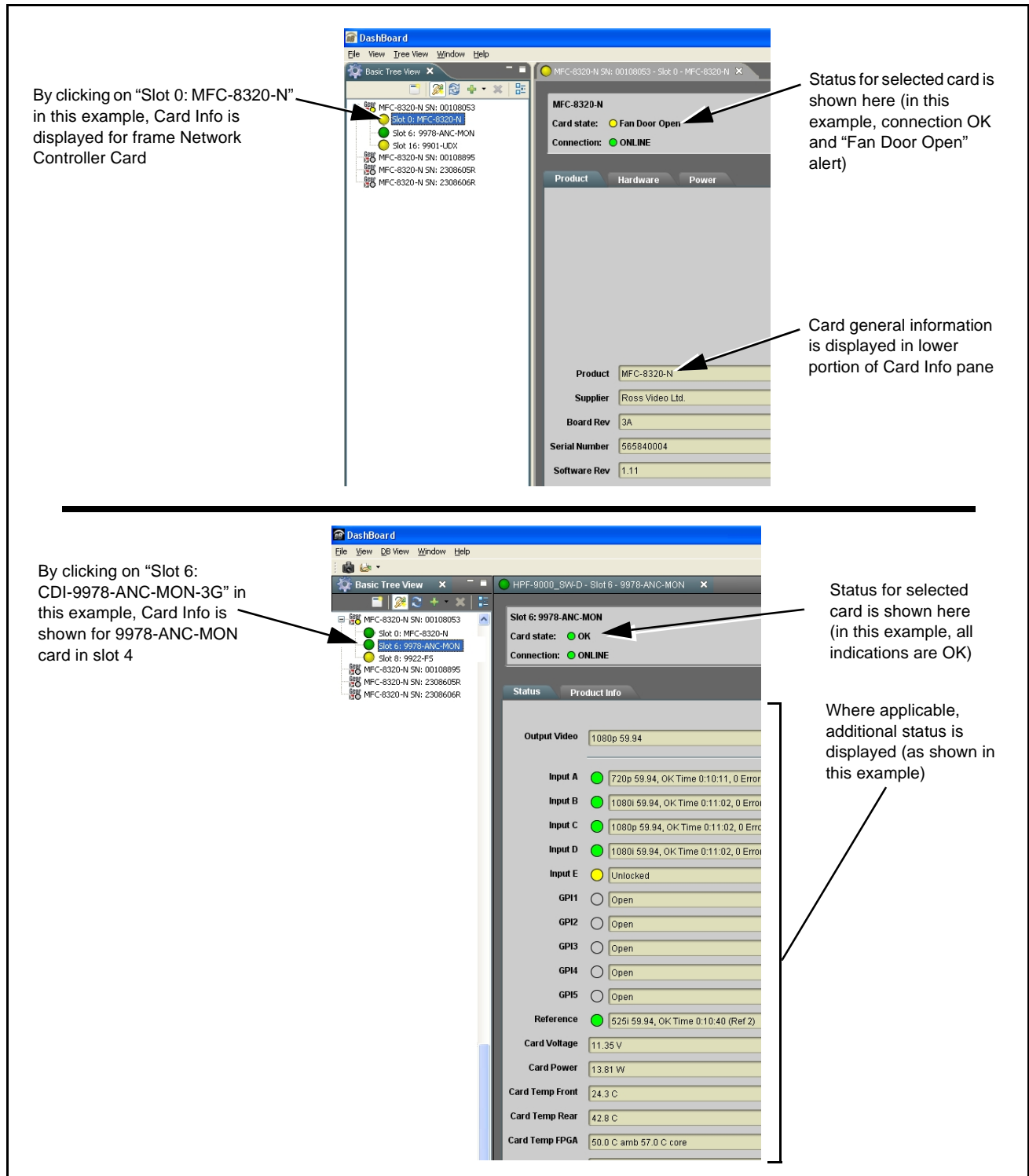

Figure 3-7 Selecting Specific Cards for Card Info Status Display

Basic Troubleshooting Checks

Failures of a general nature (affecting many cards and/or functions simultaneously), or gross inoperability errors are best addressed first by performing basic checks before proceeding further. Table 3-2 provides basic system checks that typically locate the source of most general problems. If required and applicable, perform further troubleshooting in accordance with the other troubleshooting tables in this section.

Table 3-2 Basic Troubleshooting Checks

Item	Checks
Verify power presence and characteristics	<ul style="list-style-type: none"> • On both the frame Network Controller Card and the 9978-ANC-MON, in all cases when power is being properly supplied there is always at least one indicator illuminated. Any card showing no illuminated indicators should be cause for concern. • Check the Power Consumed indication for the 9978-ANC-MON card. This can be observed using the DashBoard™ Card Info pane. <ul style="list-style-type: none"> • If display shows no power being consumed, either the frame power supply, connections, or the 9978-ANC-MON card itself is defective. • If display shows excessive power being consumed (see Technical Specifications (p. 1-15) in Chapter 1, “Introduction”), the 9978-ANC-MON card may be defective.
Check Cable connection secureness and connecting points	Make certain all cable connections are fully secure (including coaxial cable attachment to cable ferrules on BNC connectors). Also, make certain all connecting points are as intended. Make certain the selected connecting points correlate to the intended card inputs and/or outputs. Cabling mistakes are especially easy to make when working with large I/O modules.
Card seating within slots	Make certain all cards are properly seated within its frame slot. (It is best to assure proper seating by ejecting the card and reseating it again.)
Check status indicators and displays	On both DashBoard™ and the 9978-ANC-MON card edge indicators, red indications signify an error condition. If a status indicator signifies an error, proceed to the following tables in this section for further action.
Troubleshoot by substitution	All cards within the frame can be hot-swapped, replacing a suspect card or module with a known-good item.

9978-ANC-MON Processing Error Troubleshooting

Table 3-3 provides 9978-ANC-MON processing troubleshooting information. If the 9978-ANC-MON card exhibits any of the symptoms listed in Table 3-3, follow the troubleshooting instructions provided.

In the majority of cases, most errors are caused by simple errors where the 9978-ANC-MON is not appropriately set for the type of signal being received by the card.

- Note:**
- The error indications shown below are typical for the corresponding error conditions listed. Other error indications not specified here may also be displayed on DashBoard™ and/or the 9978-ANC-MON card edge status indicators.
 - Where errors are displayed on both the 9978-ANC-MON card and network remote controls, the respective indicators and displays are individually described in this section.

Table 3-3 Troubleshooting Processing Errors by Symptom

Symptom	Error/Condition	Corrective Action
<ul style="list-style-type: none"> • DashBoard™ shows Unlocked message in 9978-ANC-MON Card Info pane.  <ul style="list-style-type: none"> • Card edge Input Presence LED(s) not illuminated. 	No video input present	Make certain intended video source is connected to appropriate 9978-ANC-MON card video input. Make certain BNC cable connections between frame Rear I/O Module for the card and signal source are OK.
Cannot see one of five PiPs on output	PiP obscured by another PiP	When custom layouts are being used, it is easy for a PiP to “hide” underneath another PiP. When using this mode, size all PiPs small enough such that a PiP cannot be obscured.
Audio not processed or passed through card	Enable control not turned on	On Output Audio Routing/Controls tab, Audio Group Enable control for group 1 thru 4 must be turned on for sources to be embedded into respective embedded channel groups.
Selected Status Field does not display data as expected	<ul style="list-style-type: none"> • Wrong Input Video source selected 	<ul style="list-style-type: none"> • Make certain expected input video source is correlated and selected for the status field (see Input Video Source Select (p. 3-10)).
	<ul style="list-style-type: none"> • Status Field data type (as selected using Status Select) is not available for selected input 	<ul style="list-style-type: none"> • Some data type displays (such as LKFS and Closed Captioning) are available only for Input A (see Status (Data Type) Select (p. 3-11)).
Selected upgrade firmware will not upload	Automatic reboot after upgrade turned off	Card Presets > Automatically Reboot After Upgrade box unchecked. Either reboot the card manually, or leave this box checked to allow automatic reboot to engage an upgrade upon selecting the upgrade.

Troubleshooting Network/Remote Control Errors

Refer to Cobalt® reference guide “Remote Control User Guide” (PN 9000RCS-RM) for network/remote control troubleshooting information.

In Case of Problems

Recovering Card From SD Memory Card

New production cards come equipped with an SD card installed in a slot receptacle on the underside of the card. The data on this SD card can be used to restore a card should the card become unresponsive (can't communicate with DashBoard or other remote control). Recovering a card using the procedure here will restore the card to any installed option licenses and the most recent firmware installed.

1. (See Figure 3-8.) Make certain the card has the proper SD card installed in the under-card slot. If SD card is **not** installed, contact Product Support to obtain an SD card.

Note: If unit is a BBG-1000 Series device, remove the top cover before proceeding.

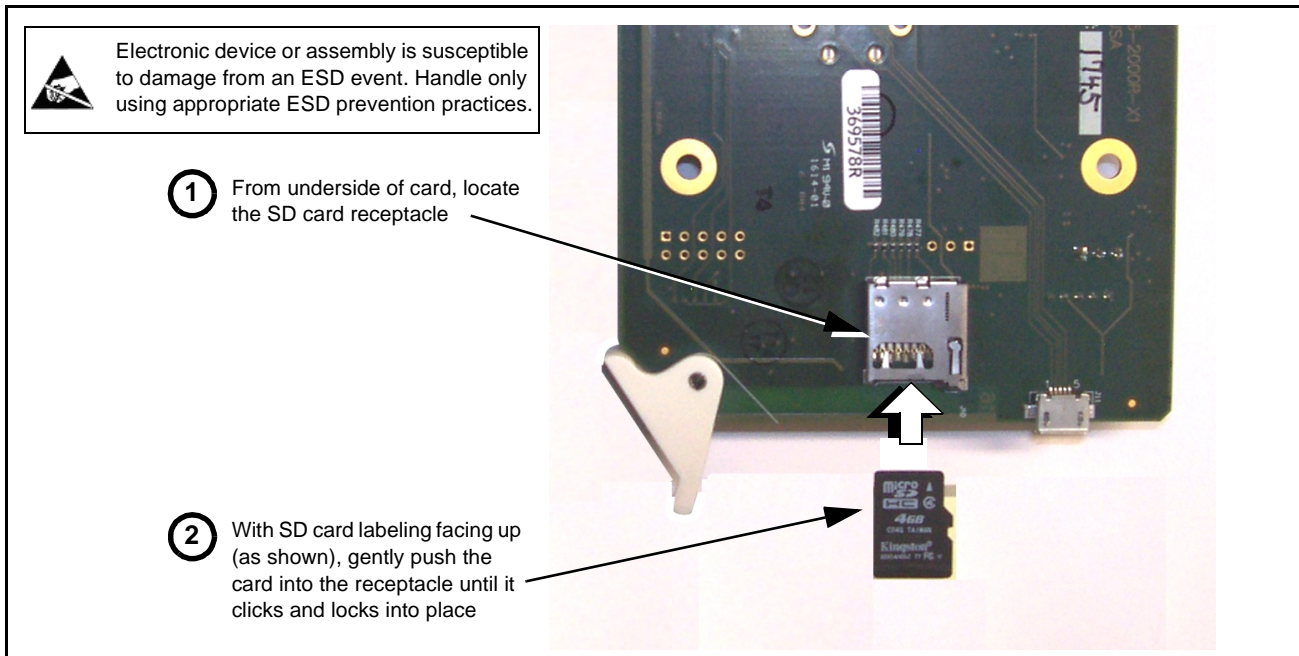

Figure 3-8 SD Card Installation

2. (See Figure 3-9.) With card powered-down, locate the **MMC BOOT** button on the card. Proceed as shown in picture.

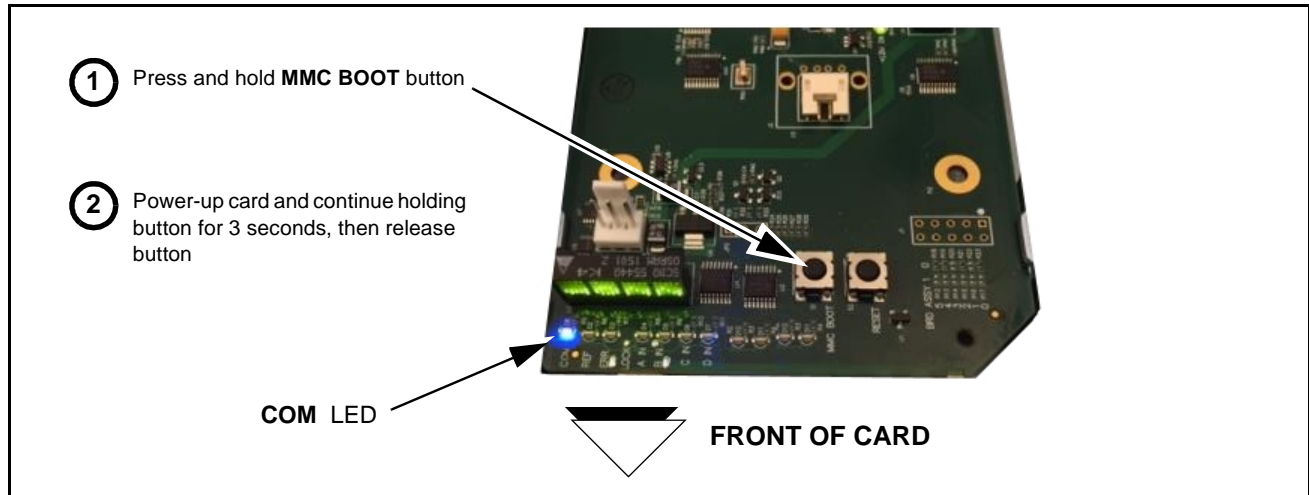

Figure 3-9 MMC Boot Button

3. With button now released, the card will begin reprogramming:
 - **COM LED** illuminates and remains illuminated.
 - When reprogram is complete, **COM LED** turns off, on, and then off again (entire process takes about 1-1/2 minute).
4. Remove power from the card (remove card from slot or power-down BBG-1000 Series unit).
5. Re-apply power to the card. The card/device will display as “**UNLICENSED**” in DashBoard/remote control.
6. In Dashboard or web remote control, go to **Admin** tab and click **Restore from SD Card**. After about 1/2-minute, the card license(s) will be restored and card will be using its most recently installed firmware.
7. Card/device can now be used as normal. On BBG-1000 Series unit, re-install top cover.

Contact and Return Authorization

Should any problem arise with this product that was not solved by the information in this section, please contact the Cobalt Digital Inc. Technical Support Department.

If required, a Return Material Authorization number (RMA) will be issued to you, as well as specific shipping instructions. If required, a temporary replacement item will be made available at a nominal charge. Any shipping costs incurred are the customer’s responsibility. All products shipped to you from Cobalt Digital Inc. will be shipped collect.

The Cobalt Digital Inc. Technical Support Department will continue to provide advice on any product manufactured by Cobalt Digital Inc., beyond the warranty period without charge, for the life of the product.

See Contact Cobalt Digital Inc. (p. 1-13) in Chapter 1, “Introduction“ for contact information.

This page intentionally blank



Cobalt Digital Inc.

2506 Galen Drive
Champaign, IL 61821
Voice 217.344.1243 • Fax 217.344.1245
www.cobaltdigital.com